

# Landslide Susceptibility Assessment in a Basement Environment using Slope and Geoelectric Parameters: Case Study of Adebowale Area, Akure Southwestern Nigeria

Adeyemo I Adedotun<sup>1</sup>

<sup>1</sup> Department of Applied Geophysics, Federal University of Technology, Akure, Nigeria

Corresponding E-mail: [iaadeyemo@futa.edu.ng](mailto:iaadeyemo@futa.edu.ng)

Received 19-03-2024

Accepted for publication 25-04-2024

Published 30-04-2024

## Abstract

The assessment of landslide susceptibility was carried out at Adebowale community in Akure South Local Government Area of Ondo State, Nigeria. A total of (60) sixty Vertical Electrical Sounding (VES) data were acquired using Schlumberger electrode configuration with a maximum half-current electrode separation (AB/2) of 150 - 225 m. The Vertical Electrical Sounding (VES) results were presented as maps and tables. The VES results delineated three to five geoelectric layers across the study area. The A, H, K, HA, KH, AKH and HKH are the seven sounding curve types delineated in the area. The resistivity of the topsoil, clayey sand weathered layer, sandy clayey weathered layer and weathered bedrock/fresh bedrock varies from 24 to 961  $\Omega\text{m}$ , 13 to 4141  $\Omega\text{m}$ , 24 to 72739  $\Omega\text{m}$  and 122 to 100000  $\Omega\text{m}$  respectively. Four parameters of importance to landslide were used to develop a landslide susceptibility model for the study. The parameters consisted of slope, topsoil resistivity, weathered layer resistivity, and longitudinal resistivity. These parameters or factors were assigned weights and ratings based on their significance to the landslide. A landslide susceptibility map (LSSM) was produced using the determined landslide susceptibility index. The LSSM classified the area into five landslide susceptibility zones; very low, low, moderate, high and very high respectively. The model was able to predict areas with very low susceptibility, low susceptibility, moderate susceptibility, high susceptibility and very high susceptibility within the study area. The northern pocket of the southwestern part of the study area revealed very low to low landslide susceptibility while the southwestern and north-central parts of the map are of moderate to very high landslide susceptibility.

Keywords: Assessment; Vertical Electrical Sounding; resistivity; landslide; susceptibility.

## I. INTRODUCTION

Generally, soil slopes occur naturally or are constructed as civil engineering structures. The stability of soil slopes is commonly determined by the equilibrium between shear stress

and shear strength. Geomaterial properties and external factors such as weathering, and seismic activity among others can influence slope stability. Other factors that can influence slope stability are support removal, overloading, transitorily effect, removal of the underlying material, lateral pressure

increment, nature of materials, weathering, pore pressure influences and structural changes [1].

Water influences, such as continuous seepage of water from slopes may reduce the slope stability thus contributing to the slope failure. Water in slopes can originate from the surface through rainfall, groundwater and underground piping or drainage system failure. The conventional method of subsurface water detection and monitoring is based on a standpipe piezometer [1]. Standpipe piezometer was designed for monitoring seepage, groundwater and pore-water pressure for slope stability evaluation. Detection of seepage in soil slope is usually costly, time-consuming and requires large data coverage.

In recent years, the geophysical method has become increasingly popular in engineering and environmental studies. Geophysics involves the study of the earth using physical properties. Common physical properties used in geophysical methods were resistivity, wave, density, magnetic susceptibility and others [2]. Geophysical methods are widely known to be cheaper, faster and can cover large areas within a shorter time. Geophysical methods can also map the subsurface in two dimensions (2-D) and three dimensions (3-D). In the past, electrical resistivity has been utilized in slope investigation works especially when dealing with difficult sites and due to high operational cost and long duration. Moreover, the indirect nature or surface technique (non-destructive method) used in geophysical data acquisitions has also enhanced their acceptability.

Geophysical methods also help to overcome some of the problems inherent in more conventional subsurface investigation techniques. Nowadays, electrical resistivity tomography (ERT) has greatly improved in terms of area coverage, field measurement and data processing making it possible to use in resolving complex geological structures compared to the electrical sounding approach. The electrical resistivity method is useful in determining the internal distribution of materials within a slope, identifying sliding surface geometry, water effect on a slope, landslide material physical properties and mass movement. One of the essential aspects of identifying risk in slopes is to determine the factor of safety (FOS) which will indicate the stability of a certain slope. In the process of obtaining the FOS, among the crucial soil parameters to be obtained before calculating FOS are cohesion ( $c$ ), internal frictional angle ( $\phi$ ), unit weight of soil ( $\gamma$ ) and others. The general approach behind this quick assessment system is to eliminate the usage of physical soil parameters such as cohesion ( $c$ ), internal frictional angle ( $\phi$ ) and unit weight ( $\gamma$ ) as is currently being practiced for the calculation of FOS and replace these physical parameters with their correlated electrical parameters such as resistivity.

Landslides in basement complex terrain pose significant threats to infrastructures, communities, and lives. This complex geological setting characterized by weathered and fractured crystalline rocks presents unique challenges for landslide investigation and mitigation. Heterogeneous rock

formations with varying degrees of weathering, fracturing, and permeability make predicting failure mechanisms and susceptibility very challenging. Consequences include the following [3]; Infrastructure damage (destruction of roads, bridges and buildings and disruption of entire transportation networks), loss of life and property (fatalities, injuries, property damage and displacement of communities) and environmental impact (can cause erosion, sedimentation and disrupt ecosystems).

Different authors in assessing landslide susceptibility in basement geologic terrain have adopted different geophysical methods and techniques.

Electrical resistivity tomography (ERT) or 2D resistivity imaging has been used in landslide susceptibility assessment. ERT was applied in geotechnical site investigation for foundation design in landslide-prone areas of Akure, Southwestern Nigeria [4]. The study utilized ERT for geotechnical site investigation in landslide-prone areas of Akure to aid the foundation design for structures to be sited in these areas. ERT was also adopted for landslide investigation in part of Akure, Southwestern Nigeria [5]. The study investigates the subsurface structure and identifies potential slip zones that can precipitate landslides in this area of Akure, Southwestern Nigeria. This study used ERT to map depth to bedrock, groundwater distribution and potential slip zones. ERT was used in investigating the possible presence of subsurface internal structures and groundwater characteristics [6] both of which can precipitate landslides. The work studied the internal structure of the Nanka Landslide in Anambra State and analyzed the distribution of saturated zones and potential groundwater contributions to instability.

A combination of ERT and other geophysical methods have been used in landslide susceptibility assessment. A combination of ERT, microgravity and seismic refraction surveys was used to assess landslide susceptibility along the Ibadan-Ife Road in southwestern Nigeria [7]. The work identified possible zones where landslides can occur along the road section. Similarly, ERT and 2D seismic refraction were applied for landslide investigation in Akure, Southwestern Nigeria. The study provided insights into bedrock depth, subsurface layers, and potential slip zones in the study area [8].

This study, however, used the vertical electrical sounding (VES) technique of the electrical resistivity method. The technique was chosen because of its ability to yield layer parameters; both primary (layer resistivity) and secondary (longitudinal resistivity, longitudinal conductance, transverse resistance). These parameters enabled the classification of subsurface materials into different degrees of water saturation and clay content.

The study area is the Adebawale community located in the Akure-South Local Government Area of Ondo State. The area is situated off Ondo-Akure road and is located within the Basement complex of Southwestern Nigeria. The study area (see Fig. 1) is located within 734163 and 736175 mE

(Eastings) and 802100 and 803421 mN (Northings) on the Universal Traverse Mercatum system.

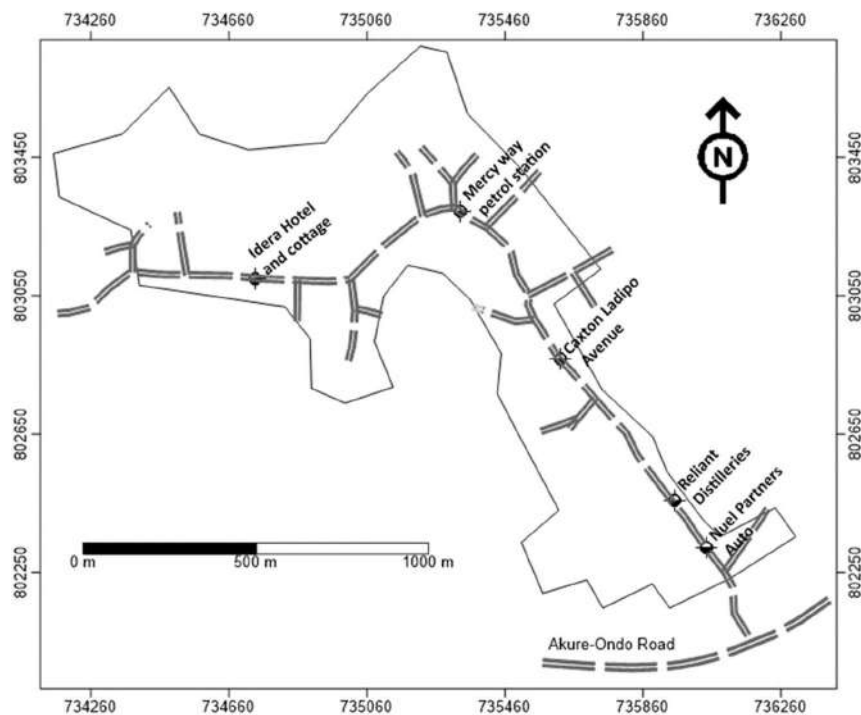

Fig. 1 Layout map of the study area.

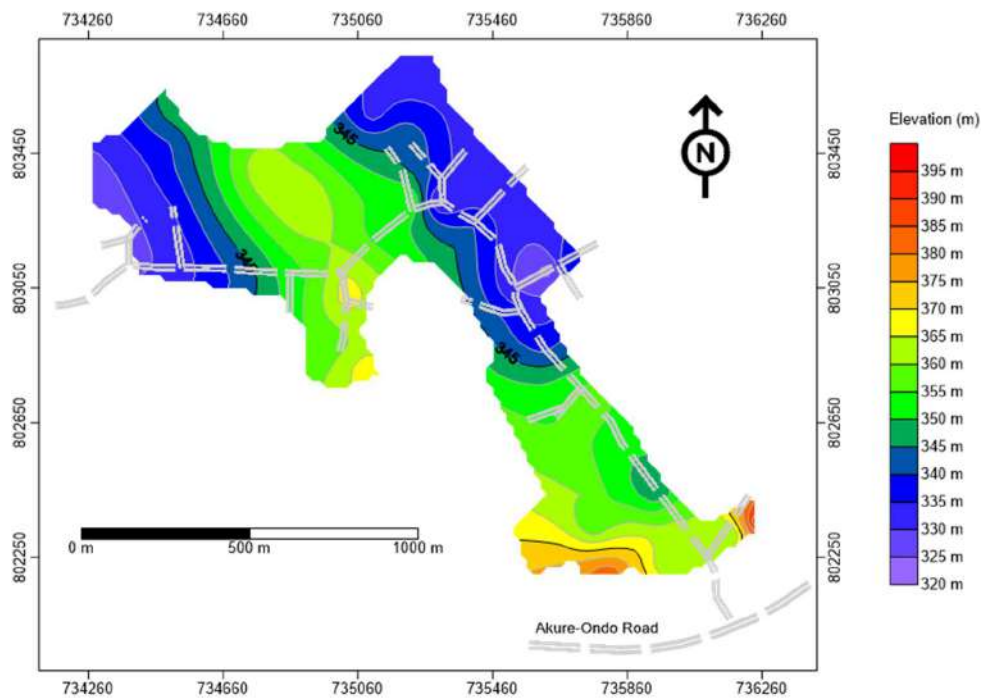

Fig. 2 Topographic map of the study area.

The study area is easily accessible through major tarred roads and many untarred roads and footpaths. The area is moderately to highly undulating with surface elevation ranging from 320 to 395 m above sea level (see Fig. 2). The climate is hot and humid, influenced by rain-bearing southwest Monsoon winds from the Sahara Desert. The rainy season lasts from April to October, with rainfall of about 152 mm per year. The average temperature is about 27°C during harmattan (December - February) and 32°C in March with a mean annual relative humidity of about 80% [9, 10]. The natural vegetation is tropical rainforest. Migmatite-Gneiss-Quartzite Complex rocks underlie the area [11, 12, 13]. The northern part of the area is predominantly quartzite while migmatite-gneiss rocks dominate the southern part (see

Fig. 3).

The study aims to establish the landslide susceptibility in the Adebowale area of Akure, Southwestern Nigeria. The study objectives include delineating the subsurface geoelectric sequence beneath the study area; generating resistivity maps of the topsoil, weathered layer and longitudinal resistivity maps of the study area; and producing the landslide susceptibility (LSS) map of the area. The study is expected to reveal the presence of possible threats to infrastructure, communities, and lives in the area. The outcome of the research can be used as a guide for future planning while making hydrogeological and environmental decisions in the area.

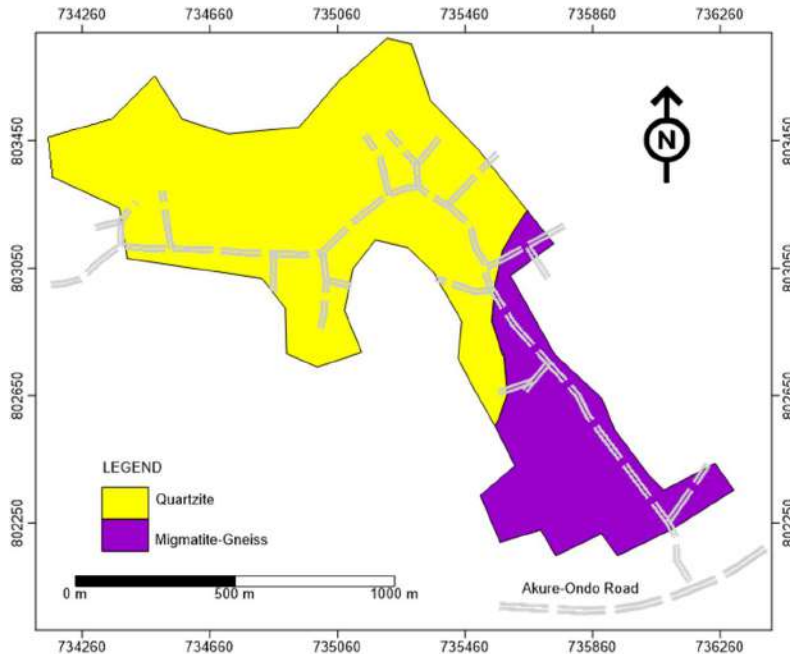

Fig. 3 Geological map of the study area.

II. METHODOLOGY

The Omega Resistivity meter was used for data acquisition. A total of sixty (60) Vertical Electrical Sounding (VES) data were acquired using Schlumberger electrode configuration with maximum half-current electrode spread (AB/2) of 150 - 225 m (see Fig. 4). The Vertical Electrical sounding (VES) results were presented as tables and maps. In VES, one-dimensional (1-D) apparent resistivity variations in the depth direction are measured. The vertical resistivity is measured with respect to a fixed centre, to acquire this; potential differences are measured at different positions of the current electrode with respect to a fixed centre, which is the station position. As the electrode separation increases, the potential difference values start decreasing. This reducing potential difference is compensated for by increasing the potential electrode separation. The apparent resistivity values of the

successive layers are calculated from the general equation of the Schlumberger array as given by (1). Layer parameters (Thickness and Resistivity) are also determined by partial curve matching of the depth-sounding curves.

$$\rho_a = 2\pi R \left[ \frac{L^2 - l^2}{4l} \right] \tag{1}$$

When  $L \gg l$  i.e.  $L^2 - l^2 \approx L^2$

Such that,

$$\rho_a = \frac{\pi R L^2}{2l} \tag{2}$$

Equation (2) can also be expressed as,

$$\rho_a = \frac{\pi R (AB/2)^2}{MN} \tag{3}$$

The apparent resistivity ( $\rho_a$ ) values were subsequently plotted on a bi-log paper as VES curves and then interpreted using the conventional manual curve matching technique [14, 15]. The interpreted results were iterated using Window Resist, a 1-D forward modelling software [16].

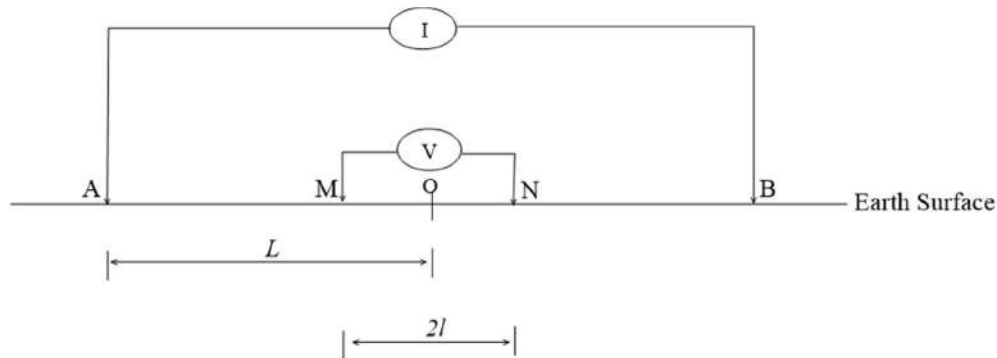

Fig. 4 Schlumberger electrode configuration [14, 15].

#### A. Landslide Conditioning Factors for Susceptibility Assessment of the Study Area

The various landslide susceptibility conditioning factors considered in this study include topsoil resistivity (TSR), weathered layer resistivity (WLR), longitudinal resistivity (LR) and slope (SL). The importance of each parameter is discussed below.

##### 1) Topsoil Resistivity (TSR)

In landslide investigation, topsoil resistivity is a critical parameter as it provides insights into the moisture content and overall stability of the surface layer. Low resistivity in the topsoil often indicates higher moisture levels, making the soil more susceptible to saturation and potential instability. Conversely, moderate to high resistivity in the topsoil suggests a balanced moisture level, contributing to stable soil conditions and reducing the immediate risk of landslides. Monitoring topsoil resistivity helps assess the vulnerability of an area to landslide hazards.

##### 2) Weathered Layer Resistivity (WLR)

Weathered layer resistivity is a key factor in landslide investigations, offering information about subsurface conditions. Moderate to high resistivity values in the weathered layer typically indicate a more stable subsurface, suggesting lower moisture content or the presence of resistive materials. This contributes to increased soil stability, reducing the immediate risk of landslides. Conversely, very high resistivity values may indicate a drier subsurface condition, further minimizing the risk of saturation-induced landslides. Understanding the resistivity of the weathered layer enhances the overall assessment of landslide susceptibility and helps identify areas with varying degrees of stability.

##### 3) Longitudinal Resistivity (LR)

In landslide investigation, longitudinal resistivity, which assesses subsurface materials along the slope's length, is crucial. High longitudinal resistivity suggests less conductive or resistive subsurface materials, potentially indicating increased stability due to lower moisture content or materials less prone to saturation. On the other hand, moderate to low longitudinal resistivity may signify more conductive or less resistive subsurface materials, implying higher moisture content and potential instability. Monitoring longitudinal

resistivity aids in evaluating the risk of landslides by providing insights into the conditions along the slope's profile.

##### 4) Slope (SL)

The slope is a fundamental aspect in landslide investigation, influencing the stability of terrain. Steep slopes are generally more prone to landslides due to increased gravitational forces. Factors such as slope angle, material composition, and vegetation cover impact slope stability. Detailed analysis of slope characteristics helps assess landslide susceptibility, with steeper slopes often posing higher risks. Monitoring changes in slope conditions is essential for early detection and mitigation strategies in landslide-prone areas.

### III. DISCUSSION OF RESULTS

The Vertical Electrical sounding (VES) was carried out in the study area and a total of (60) sixty VES points were located. The VES results were presented as maps and tables. The VES results delineated three to five geo-electric layers across the study area. Seven different sounding curve types delineated in the area were A, H, KH, K, HKH, HA and AKH (Table 1). The resistivity of the topsoil, clayey sand weathered layer, sandy clayey weathered layer and weathered bedrock/fresh bedrock varies from 24 - 961  $\Omega\text{m}$ , 13 - 4141  $\Omega\text{m}$ , 24 - 72739  $\Omega\text{m}$  and 122 - 100000  $\Omega\text{m}$  respectively. These field curves and the layer parameters are reflections of the successive lithological sequence in any geologic environment and hence can be used to study the area.

#### A. Topsoil Resistivity

The resistivity distribution of the topsoil in the study area is shown in the topsoil resistivity map. The map categorized the area into five zones (very low, low, moderate, high, and very high). The map (see Fig. 5) utilizes distinct colors; blue, ice blue, spring green, yellow and pink to represent different zones corresponding to different ranges of resistivity values (0 - 60  $\Omega\text{m}$ , 61 - 150  $\Omega\text{m}$ , 151 - 350  $\Omega\text{m}$ , 351 - 450  $\Omega\text{m}$ , and greater than 451  $\Omega\text{m}$ ). Zones of very low resistivity are observed in the northeastern and pockets of the southwestern area suggesting higher moisture content and increasing susceptibility to saturation and soil instability. The north-eastern, north-western, and southwestern parts indicate



moderate to high topsoil resistivity, indicating a balanced moisture level, stable soil conditions and lowered landslide risk. The zone of very high topsoil resistivity in the

northeastern parts signifies a well-drained soil condition with lower moisture content and possibly stable topsoil with minimal landslide susceptibility risk.

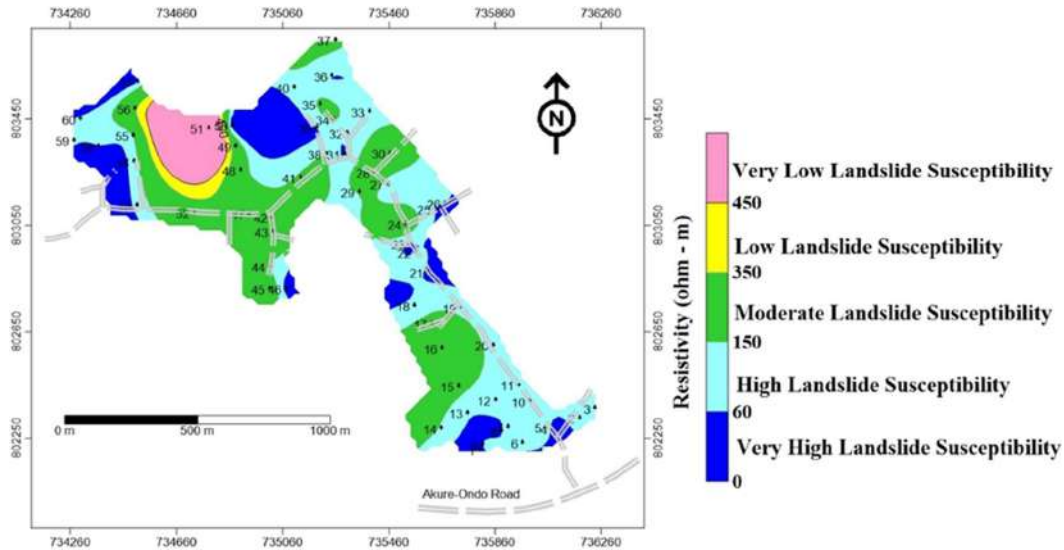

Fig. 5 Topsoil resistivity map of the study area.

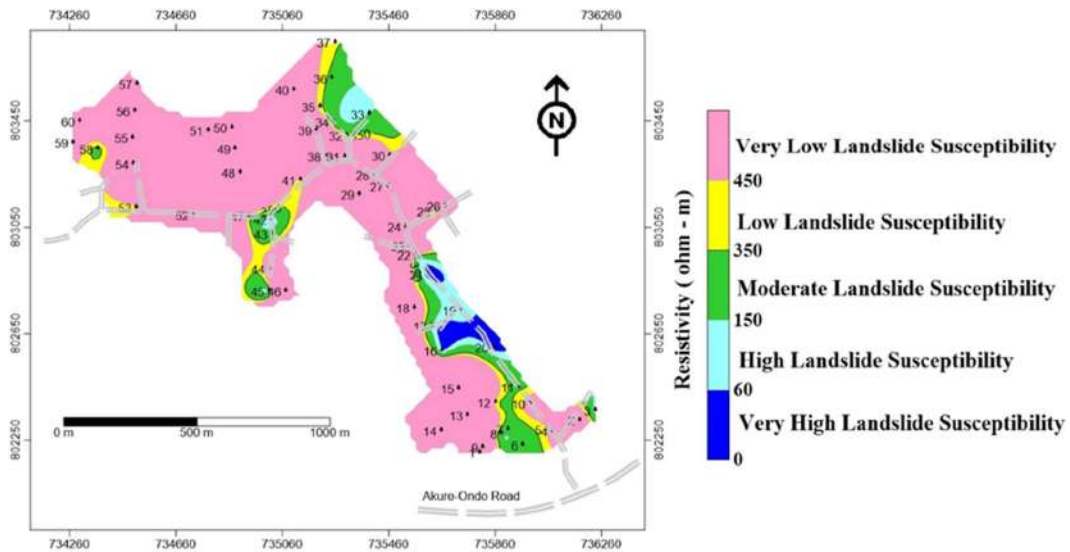

Fig. 6 Weathered layer resistivity of the study area.

**B. Weathered Layer Resistivity**

The weathered layer resistivity map (Fig. 6) shows the iso-resistivity distribution of the weathered layer in the study area. The map categorized the area into five zones using different resistivity ranges (0 - 60  $\Omega$ m, 61 - 150  $\Omega$ m, 151 - 350  $\Omega$ m, 351 - 450  $\Omega$ m, and greater than 451  $\Omega$ m). In the southwestern and pockets of places in the northern part of the study area. The weathered layer exhibits very low to low resistivity values, possibly indicating the presence of more conductive materials or higher moisture content, suggesting potential instability. Conversely, the northern, northeastern, and southwestern

regions display moderate to high resistivity values, signifying a more stable subsurface condition with lower moisture content or the presence of resistive materials. Such conditions, associated with a balanced moisture level, may reduce the immediate risk of landslides. The prevalence of very high resistivity values across the map suggests a drier subsurface condition, contributing to increased stability by minimizing the risk of saturation-induced landslides. Areas with very high resistivity values in the weathered layer are considered less prone to immediate landslide risks in landslide investigations.

Table I Vertical Electrical Sounding Results

VES No	Easting (m)	Northing (m)	Resistivity $\rho_1/\rho_2/\dots/\rho_n$ ( $\Omega\text{m}$ )	Thickness $h_1/h_2/\dots/h_n$ (m)	Curve Type
1	735803	802200	24/167/16130	3.3/1.8	A
2	736178	802320	87/814/1861	4.3/19.9	A
3	736237	802356	78/77/2023	1.9/2.1	H
4	736074	802278	41/576/3699	8.5/10.8	A
5	736052	802285	79/415/8238	5.6/62.2	A
6	735964	802226	69/188/3093	12.5/7.1	A
7	735909	802286	76/255/2167	3.8/12.4	A
8	735885	802270	46/73/633	2.7/1.4	A
9	735814	802218	69/1260/34408	6.8/16.4	A
10	735991	802382	68/587/4828	5.9/10.2	A
11	735950	802444	75/332/3097	1.2/16.3	A
12	735861	802387	88/368/250/786	0.6/2.0/13.8	KH
13	735756	802339	68/2521/407/7192	0.4/0.6/23.2	KH
14	735658	802280	136/4141/113/4360	1.9/3.3/12.1	KH
15	735723	802439	183/2675/380/61994	2.2/1/1/38.0	KH
16	735660	802581	328/40/590/132/14465	0.4/0.7/0.8/56.8	HKH
17	735621	802673	227/121/36742	0.4/34.7	H
18	735556	802742	88/796/24/11995	1.8/2.4/10.5	KH
19	735730	802733	129/156/39255	0.3/12.3	K
20	735853	802593	112/13/562	1.3/1.3	H
21	735607	802867	57/15/88/100000	1.9/1.9/1.7	HA
22	735560	802941	79/125/72739	1.5/5.0	A
23	735538	802974	31/2665/25/38127	0.4/0.8/2.1	KH
24	735524	803047	232/1650/115/4245	0.8/2.7/11.2	KH
25	735635	803105	56/145/3583	4.0/13.7	A
26	735672	803125	57/2010/96	0.8/0.9/8.2	KH
27	735458	803199	89/1412/246	0.7/1.2/17.2	KH
28	735405	803242	281/2171/139/5396	2.3/2.9/12.3	KH
29	735348	803169	150/1099/280/1758	1.5/3.1/21.1	KH
30	735464	803314	252/472/108/10948	1.0/4.3/20.9	KH
31	735294	803311	57/1480/50/92504	0.4/1.0/5.0	KH
32	735303	803389	67/321/319/9092	1.3/0.3/43.2	A
33	735386	803470	102/164/3502	1.0/30.2	A
34	735253	803441	157/250/792	1.0/31.2	A
35	735201	803498	168/391/2877/178/23084	0.5/4.1/6.3/31.6	AKH
36	735246	803604	59/295/493/34188	0.5/1.2/48.9	A
37	735258	803740	177/373/154/2018	1.0/2.1/20.3	KH
38	735223	803311	154/2210/128/2582	2.6/3.1/8.9	KH
39	735188	803410	48/1058/1154/122/100000	0.9/1.9/3.6/10.2	AKH
40	735102	803562	113/849/220/2019	0.9/0.8/4.4	KH
41	735127	803223	162/339/1454	4.6/0.7	A
42	735020	803074	194/38/447/188/3186	0.6/0.4/6.2/18.1	HKH
43	735022	803019	249/268/2019	1.1/9.5	A
44	735011	802889	156/578/4597	1.2/8.2	A
45	735010	802804	271/42/1343/100000	0.3/0.8/24.7	HA
46	735073	802805	52/2725/458/4149	0.7/1.2/70.4	KH
47	734934	803087	282/307/1060	2.3/6.6	A
48	734900	803251	192/2994/2725	1.7/7.2/34.1	KH
49	734883	803340	252/419/27272	3.1/13.8	A
50	734870	803420	35/1110/1433	1.1/27.4	A
51	734780	803409	961/466/44984	12.8/9.6	H
52	734726	803090	283/3439/538/6139	0.8/1.6/29.3	KH
53	734511	803120	88/382/119/20431	1.3/7.4/6.9	KH
54	734500	803282	89/1328/1456	1.7/76.7	A
55	734497	803382	131/660/6388	2.3/38.1	A
56	734504	803482	358/2067/2858	3.9/23.7	A
57	734513	803583	79/1897/169/76994	2.0/4.0/16.5	KH
58	734366	803339	56/258/17610	0.9/12.6	A
59	734272	803363	99/681/70955	1.0/49.3	A
60	734297	803443	81/622/10737	1.4/35.6	A

C. Longitudinal Resistivity

The longitudinal resistivity map of the study area (Fig. 7) shows the distribution of longitudinal resistivity across the area. The map divided the area into five zones (very low, low, moderate, high and very high) based on different resistivity ranges (0 - 60 Ωm, 61 - 150 Ωm, 151 - 350 Ωm, 351 - 450 Ωm, and greater than 451 Ωm). The northeastern part of the study area is characterized by very high resistivity values, which possibly suggests the presence of less conductive or resistive subsurface materials along the length of a slope. This condition may contribute to increased stability by indicating

lower moisture content or the presence of materials less prone to saturation and the northern flank and southwestern flank shows moderate to very low resistivity values that may imply the presence of more conductive or less resistive subsurface materials along the length of a slope. This condition could indicate higher moisture content or materials prone to saturation, suggesting potential instability. In landslide assessments, areas with moderate to low longitudinal resistivity values might be associated with a higher risk of landslides due to the likelihood of increased moisture content, potentially compromising the stability of the slope.

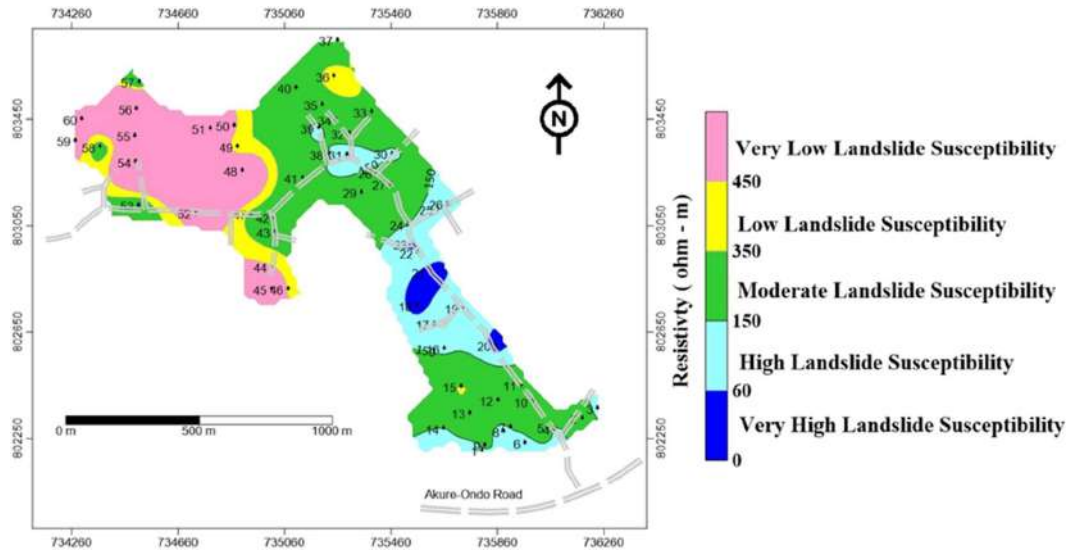

Fig. 7 Longitudinal resistivity map of the study area.

D. Slope Map

This map (Fig. 8) shows that the study area is moderately to highly undulating with elevation ranging from 320 - 384 m. The higher the elevation of the area the higher the slope, while the lower the elevation the lower the slope. The slope map (Fig. 7) divided the area into five zones (very high, high, moderate, low and very low zones) based on the developed class interval as indicated in the map. The map shows that the northern region of the study area, which has a very low elevation of 320 - 336 m, has very low landslide susceptibility. Low elevation falls between the class of 337 - 352 m and these were observed in the north-eastern and part of the southwestern region. The north-eastern and southwestern region of the study area shows moderate elevation with a range of 353 - 368 m while the high elevations fall within the elevation range of 369 - 384 m and the very high elevation class (greater than 385 m), which is evident at the southwestern region of the study area.

E. Landslide Susceptibility Index Estimation

The landslide susceptibility index estimation was done by multiplying the assigned weight “W” with the corresponding rating “R” for each factor [17]. After that, all the products of

“W” and “R” are added together for each VES point. The technique employed for calculating LI is referred to as the Weighted Linear Average Method. The LI equations are presented as (4) and (5).

$$LI = \sum W_i R_i \tag{4}$$

Where  $W_i$  is the weight of parameter “i” and  $R_i$  is the rating score of parameters “i”

Therefore,

$$L = W_{TSR}R_{TSR} + W_{WLR}R_{WLR} + W_{LR}R_{LR} + W_{SL}R_{SL} \tag{5}$$

Where subscripts: TSR, WLR, LR and SL are the topsoil resistivity, weathered layer resistivity, longitudinal resistivity and slope respectively.

F. Landslide Susceptibility Map

To enhance comprehension and visualize the susceptibility of the study area (Fig. 9) to landslides, the resulting index from each method underwent classification into five distinct categories. The landslide index derived from the contributing factors, as determined by (4) and (5), was generated using Surfer 13 software. The study area was then categorized into



five classes: very low, low, moderate, high, and very high susceptibility zones, each marked with unique colour distinctions. The susceptibility ranges are as follows: (0.29 - 0.42, 0.43 - 0.54, 0.55 - 0.67, 0.68 - 0.80, and 0.81 - 0.92) respectively. Regions with very low to low landslide susceptibility are evident in the northern, northeastern, and certain portions of the southwestern sections of the map,

signifying a very low susceptibility level. However, areas with moderate landslide susceptibility are identified in the southwestern and some pockets of the north-central part of the map, indicating a low susceptibility degree. Notably, on the southwestern flank, there is a zone with high to very high landslide susceptibility, emphasizing a high degree of susceptibility in that particular area of the study region.

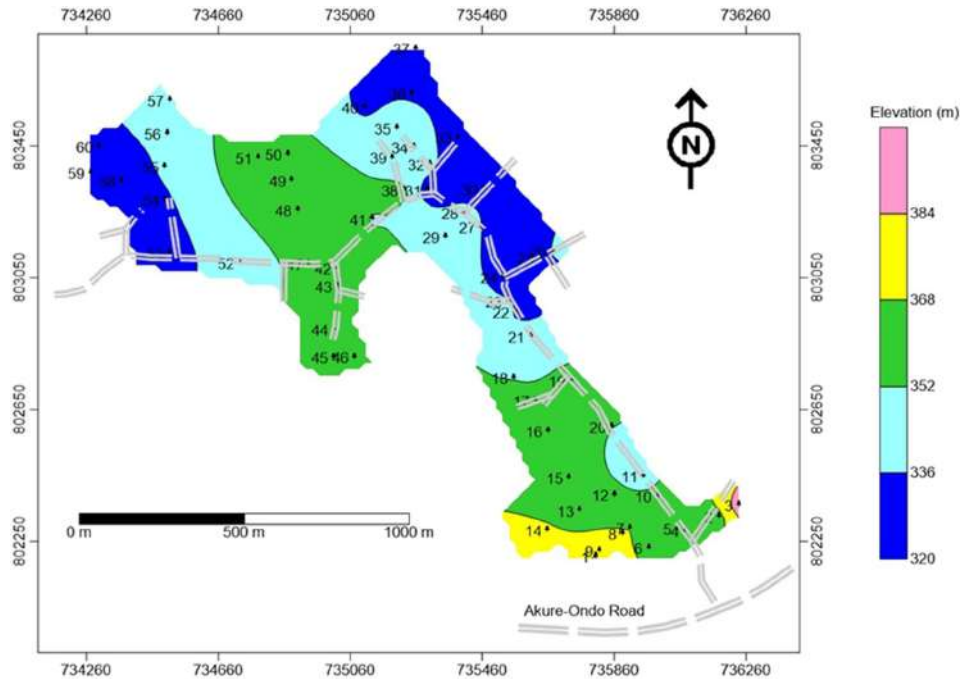

Fig. 8 Slope map of the study area.

Table II Ratings and Weights for Classes of Factors

Influencing Factors	Classes	Susceptible potentiality for Landslide	Rating (Unstandardized Values)	Weights (W)
Top Soil Resistivity (TSR)	0 - 60	Very High	1	0.15
	61 - 150	High	0.8	
	151 - 350	Moderate	0.6	
	351 - 450	Low	0.4	
	> 451	Very Low	0.2	
Weathered Layer Resistivity (WLR)	0 - 60	Very High	1	0.20
	61 - 150	High	0.8	
	151 - 350	Moderate	0.6	
	351 - 450	Low	0.4	
	> 451	Very Low	0.2	
Longitudinal Resistivity (LR)	0 - 60	Very High	1	0.25
	61 - 150	High	0.8	
	151 - 350	Moderate	0.6	
	351 - 450	Low	0.4	
	> 451	Very Low	0.2	
Slope (SL)	320 - 336	Very low	0.2	0.4
	337 - 352	Low	0.4	
	353 - 368	Moderate	0.6	
	369 - 384	High	0.8	
	385 - 400	Very High	1.0	

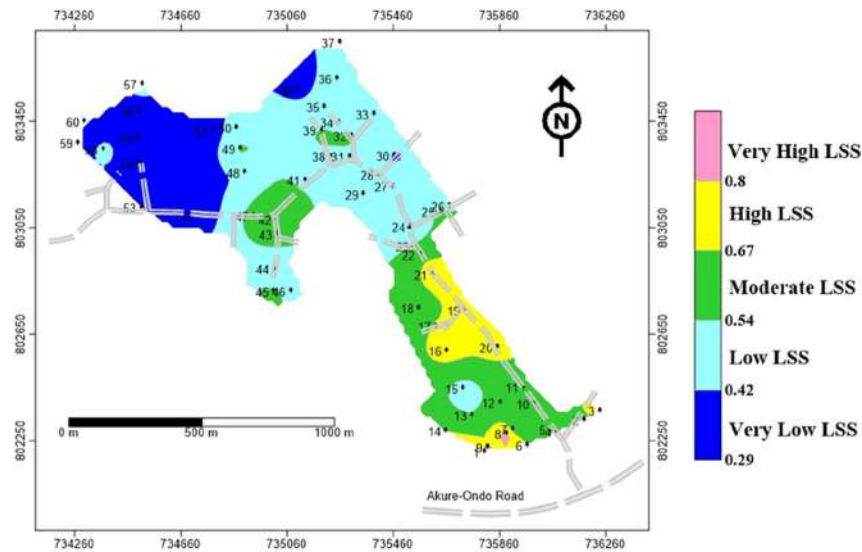

Fig. 9 Landslide susceptibility map of the study area.

IV. CONCLUSION

In this study, a geophysical investigation was conducted at Adebowale community, located in Akure South Local Government Area of Ondo State. The area falls within the Basement complex of Southwestern Nigeria. The Adebowale community is underlain by two rock types, Quartzite and Migmatite Gneiss. The study aims to assess the landslide susceptibility in the area using the integration of topographic and geo-electric parameters. 60 VES data was acquired within the study area. The VES results were presented as tables and maps. The results delineated three to five geo-electric layers across the study area. The seven sounding curve types delineated in the area consist of A, H, KH, K, HKH, HA and AKH.

The first and second-order geo-electric parameters namely, topsoil resistivity, weathered layer resistivity and longitudinal resistivity were combined with the surface elevation or slope of the study area. These parameters were integrated to form the landslide susceptibility map for the study area. To enhance the accuracy of the landslide susceptibility model map. The influencing factors were assigned appropriate weights and ratings and the calculated landslide susceptibility index ranges between 0.29 - 0.92. The model was able to predict areas with very low susceptibility, low susceptibility, moderate susceptibility, high susceptibility and very high susceptibility within the study area. In the study, the most significant impact parameter is the slope/elevation while the topsoil resistivity has the lowest significant impact in the susceptibility map. The northern pocket of the southwestern part of the study area comprises very low to low landslide susceptibility while the

southwestern and north-central part of the map consists of moderate to very high landslide susceptibility.

ACKNOWLEDGEMENT

I am grateful to the Department of Applied Geophysics, Federal University of Technology, Akure, Nigeria for allowing the use of Ohmega resistivity and other accessories used for this research work. I sincerely expressed my profound appreciation to Mr. Faleye Oluseye E. and the following friends and students; Aruwaji Success I., Gade Adefolarinwa E., Korode Fuad O., Olaniyan Opeyemi A. and Omole Boluwaji F. of the same Department who assisted in acquiring data for this research work.

Reference

- [1] D. J. Varnes “Landslide types and processes”. In: Turner A.K. and Schuster R.L. (eds) *Landslides: Investigation and Mitigation, Transportation Research Board Special Report 247*. National Academy Press, National Research Council, Washington, D.C, 1996.
- [2] W. M. Telford, L. P. Geldart, R. E. Sheriff and D. A. Keys, “Applied Geophysics” (2<sup>nd</sup> Edition), *Cambridge University Press*, pp 344 - 536, 1990.
- [3] L. Shano, T. K. Raghuvanshi and M. Meten, “Landslide susceptibility evaluation and hazard zonation techniques” -A review. *Geoenvironmental Disasters*, vol. 7, no. 18, pp. 4, 2020.
- [4] E. A. Ayolabi, A. F. Folunso and O. E. Jegede, “An application of 2D electrical resistivity tomography in geotechnical site investigation for foundation design in landslide prone areas of Akure, Southwestern

- Nigeria”. *European Scientific Journal*, vol. 19, no. 12, pp. 121 - 136, 2013.
- [5] O. O. Olajide, and M. A. Fatokun, “Application of electrical resistivity tomography for landslide investigation in Akure, southwestern Nigeria”. *Journal of African Earth Sciences*, no. 119, pp. 399 - 410, 2016.
- [6] E. E. Chikwelu, and N. Chetty, “Use of electrical resistivity tomography in investigating the internal structure of a landslide and its groundwater characterization in Nanka Landslide, Anambra State, Nigeria”. *Journal of African Earth Sciences*, 183, 104375, 2021
- [7] A. A. Adepelumi, K. O. Oyinloye and T. O. Adebayo, “Integrated geophysical survey for landslide assessment in a tropical environment: a case study of the Ibadan-Ife Road, southwestern Nigeria”. *Bulletin of Engineering Geology and the Environment*, vol. 71, no. 3, pp. 07 - 216, 2012.
- [8] O. O. Olajide, A. A. Adegbola M. A. and Fatokun, “Application of electrical resistivity tomography and 2D seismic refraction for landslide investigation in Akure, southwestern Nigeria”. *Journal of Applied Geophysics*, 111, pp. 125 - 136.
- [9] N. P. Iloje, “A new Geography of Nigeria” (*New Revised Edition*). London, UK; Longman Group, 1980.
- [10] I. A. Adeyemo, A. I. Afolayan, B. S. Boluwade and S. K. Alabi, “Subsurface Geotechnical Competence Evaluation Using Geoelectric Sounding and Direct Cone Penetrometer Test at Plural Garden Estate, Iaramokin Southwestern Nigeria”. *Indonesian Journal of Earth Sciences*, DOI: 10.52562/injoes.2023.618, pp. 1 - 11. 2023.
- [11] M. O. Oyawoye, “The basement complex of Nigeria” *In Africa Geology (edited by Dessauvage, T.F.J. and Whiteman A.J), Ibadan Nigeria*, pp. 67 - 99, 1972.
- [12] M. A. Rahaman, “Review of the basement geology of South-Western Nigeria” *In Kogbe C. A. (ed) Geology of Nigeria, 2<sup>nd</sup> Edition, Elizabethan Publishers, Lagos*, pp. 41 - 58, 1976.
- [13] M. A. Rahaman, “Recent advances in the study of the basement complex of Nigeria”. *In: Geological Survey of Nigeria (ed) Precambrian Geology Nigeria*, pp. 11 - 43, 1989.
- [14] G. V. Keller and F. C. Frischknecht, “Electrical Methods in Geophysical Prospecting”. *Pergamon Press, Oxford*, 1996
- [15] O. Koefeod, “Geosounding principles, 1. Resistivity sounding measurements” Elsevier Scientific Publ. Comp, Amsterdam, p 275, 1979
- [16] B. P. A. Vander Velpen, “Resist version 1.0” M.Sc. Research Project, ITC, Delf, Netherland, 1989
- [17] G. H. Tzeng, T. Y. Chen and J. C. A. Wang, “Weight-assessing method with habitual domains”. *European Journ. Oper. Res.*, no. 110, pp. 342 -367, 1998.