



Enhancement of Yam Pounding Machine for Automatic Domestic and Commercial Optimal Operations

K. E. Jack^{1*}, J. Bello², S. O. Akpa³, A. B. Inyang⁴

^{1,2,3}Department of Mechatronics Engineering, Federal University of Technology, Niger State – Nigeria.

⁴Department of Electrical/Electronics Engineering, Akwa Ibom State Polytechnic, Ikot Osurua, Ekpene, Akwa Ibom State - Nigeria.

*kufre@futminna.edu.ng

Research Article

Abstract

Today's advancement in technology has prompted innovation of techniques for large scale food processing for domestic and industrial purpose. This tasks relevant engineering stakeholders with the development of better processing models. Food preparation and consumption is a daily necessity of man and this makes it important to innovate methods that simplify this routine in satisfying his natural appetite. Gelatinous diets such as pounded yam and also powdered ingredients or grains take substantial amount of time and energy when manually processed. For this reason, designing and fabricating an automatic machine for yam pounding would reduce the processing time, ensure safety, hygiene and reduced human effort. This automatic machine adopts an electromechanical mechanism for its enhancement. The mechanical parts use wood and mild steel whereas electrical parts use electronic components and a microcontroller. The aforementioned controller helps to automate the operation of an electric motor for pounding and also for stirring, based on sensor information obtained. The mechanical and electrical parts of this model were put together to realize a mini model with 0.2m and 0.1m as the designed diameter and height respectively. The designed model was able to be accomplished and prototype demonstrated, the torque value of 0 to 0.2Nm gives zero (0Rev/Min) of speed and zero (0W) of power. At torque values of 0.3 to 0.25 Nm gives a rise in speed and power to the magnitude of 15 to 60 Rev/Min, with the corresponding power of 0.47 to 1.57W respectively. This implies that the cooked yam is being processed. When the constant torque values of 0.24Nm was recorded against 75 to 105 Rev/Min of speed, with the corresponding power values of 1.89 to 2.64 W. This shows that the cooked yam has completely been processed and the microcontroller initiates an action to bring the process to an end as provided by the pseudocode for this model.

Copyright © Faculty of Engineering, Ahmadu Bello University, Zaria, Nigeria.

Keywords

Automatic; Domestic applications; Enhancement; Machine; Yam Pounding.

Article History

Received: October, 2021

Accepted: August, 2022

Reviewed: January, 2022

Published: August, 2022

1. Introduction

Technical consciousness has made it possible to imagine and conceive more enhanced mechanisms towards providing alternatives to existing solutions and better economical options to satisfy demands from technology and society. In the light of recent technology, automation has become the most important constituents in the manufacturing sector to enhance productivity. Automation of processes changes the working environment and the working conditions by making the system simpler and cheaper to the engineer and also importantly, safer for workers (Mishev, 2006). Before now pounding was achieved locally with the use of wooden mortar and pestle where items in the mortar are continuously deformed when a downward force is being exerted through the pestle by one or more users. To west Africans and particularly Nigerians, pounded yam remains an important and highly rated nourishment, preferred and highly demanded by many individuals (Nweke, 2019). The manual pounding method is very laborious and time consuming depending on the quantity to pound. At the moment, the global food industry would find it much profitable when the food processing and packaging

operations are suitably improved and adapted. Therefore, food companies and businesses strive to explore and invest in techniques and methods that increase product quality and customer preference for their products while boosting overall production (Sani et al, 2013). The existing yam processing machines were developed to stir the yam for a long period before the required consumption texture is achieved, this creates some inadequacy in the texture of the processed yam thereby leaving behind some yam lumps which results to wastage. In executing such laborious and dull tasks within the minimum possible time, and also for removing discomforts associated with executing large consignment orders, automation could provide the most satisfactory solution. Hence the enhancement of the already existing automatic pounding machines for better efficiency and increased economic benefits to key industrial sectors and the global food organization. The enhancement introduced by this research is the introduction of a vertical pounding mechanism in addition to the stirring mechanism which is the widely adopted technique, this engenders a better texture of the processed yam.

In Nigeria, average frequencies of consumption were 65 percent from fresh yam tuber, 25 percent from traditionally processed products and merely 10 percent from industrially processed product. The consumption frequency of pounded yam was observed to grow from low-income earners through medium income to the upper income earning class of the society. Members of the medium income group who cannot afford pounded yam settle for *poundo* yam which is the industrially processed dry tuber flour. The research discovered that consumers have higher preference for yam food prepared from fresh tubers compared to that prepared from the processed flour which is the reason it is much less demanded. Affordability of pounded yam is also influenced by availability of pounding facilities. The traditional pounding method produces noise that could disturb residents of a neighbourhood or apartment. Hence it is not suitable for especially large quantity production (Nweke, 2019).

Food processing entails the transformation of raw ingredients, substances and intermediate items into finished products that are suitable for human ingestion and consumption. This processing is carried out for various purposes which includes to improve the bioavailability, flavor, appearance, safety, storability and supply of food items. Food science and technology professionals remain committed to enabling supply of safer and healthier food to consumers as demand continues to increase and the global food system continues to evolve. This further draws the attention of engineering professionals towards providing the required machinery for the food processing task (Eker & Icoz, 2017). Manual pounding activities are laborious because it involves Valsalva, which is unsuitable for some health challenged persons. If sick patients are inadequately trained in the appropriate breathing technique, undue heightening of blood pressure may result from the pounding activity. Caution may therefore also be warranted in permitting this activity for hypertensive patients (Oyeyemi et al., 2017). Some of the challenges owing to the manual pounding procedure were mitigated with the advent of the automatic pounding system. Among several efforts made in the past towards proffering solution to the problem of local pounding process includes Ikechukwu et al. (2015), developed a yam pounding machine where two curved beaters (flap) were assembled in a pounding chamber to crush the contents in between the chamber walls and the beaters, their design was challenged with the frequent overheating of the drive as the motor operates. Again, (Puoza et al., 2016) developed a motorized cassava (fufu) pounding machine as a combination of auger and die. In their design, boiled cassava was loaded into the hopper where the auger breaks the boiled cassava into mash and moves it to the die where the auger rotation builds up pressure to force the mash through the die. Compressed pellets are formed which are finally collected at the discharge outlet. Their design needed to be improved upon having observed that mashing and stirring would have mitigated the inadequacies. Adopting a design which combines the pounding, mashing and stirring would be a significant improvement.

Owing to the importance attached to pounded yam in Africa and Nigeria in particular, an electrically driven device was

developed and characterized for yam mechanized pounding by other researchers. Their design uses an electric motor to provide the power which drives the propeller or yam beaters as it was similarly done in (Ikechukwu et al., 2015) design, but an improvement on the previous design introduces cooling vents to reduce overheating of electric motors and also the use of dampers to minimize vibrations in the design (Uchenna et al., 2015).

(Chaturvedi et al., 2018) designed a lever-engine based pounding machine in which a camshaft was arranged to lift heavy steel pounds from the side, so that it causes the pound to reciprocate. In their design, the camshaft was made to travel from underneath the assembly thereby making the pounds to fall onto the substance beneath it and crushing it while the process was repeated at the next drive of the cam. Substances such as rock, spices, roots, etc can be pounded,

(Oisehoemomen et al., 2020) demonstrated its designed pounding machine for a short duration and it reveals its ability in carried out an automatic pounding within the design capacity of 3kg using 1hp electric powered motor.

In another development, (Yohanna, 2019) designed and modified an existing pounding machine, where an electric motor generates a torque that transmits motion through a v-belt from the driver pulley to the driven pulley. The torque generated by the driven pulley transmits a rotational motion which was transferred to a dual beater to crush the lumps against the wall of the mixing chamber. The researcher further recommended that an improvement could be made on pounding the yam by vertical motion to curtail the design shortcomings. Onuoha et al, (2019) developed and validated the concept of yam pounding machine in order to minimize the drudgery in the manual method, improve hygiene and appeal of pounded yam. The design comprises of two chambers, one cooks while the other pounds. A petrol engine provides power to engage and disengage the horizontal gear which transmits power to a vertical gear to rotate two beaters inside the pounding bowl. The research witnessed major setbacks ranging from noise emanating from petrol engine, high cost of running the system and still require much manual labor input.

The literature reviewed so far reveals quite a number of inadequacies and setbacks that needs further improvements with the advent of this model. This research adopts a model that incorporates a vertical pounding mechanism as an improvement upon the already existing stirring mechanisms which is aimed at increasing the pounding machine efficiency with an operation time.

2. Methodology

Yam pounding machine in different designs are already in existence, this design understudied them with the view of improving on their performance by adding a vertically reciprocating pounder mechanism which alternates with the stirrer mechanism to pound the yam uniformly. This design is divided into four units which are the control, sensing, actuating and power source. The control unit comprises of the Microcontroller which fetches information from the sensors to determine the start and end of the pounding operation.

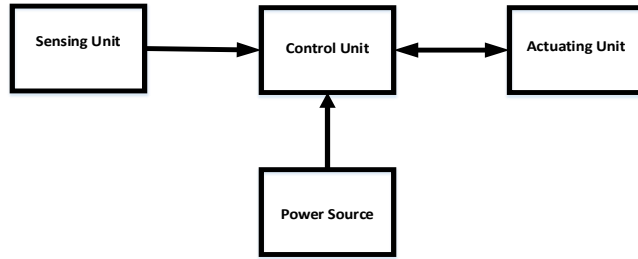

Figure 1: Block diagram of an Enhanced Automatic Yam Pounding Machine

The stepper motor was selected for this design because of the following specifications: single pole, unipolar, permanent magnet stepper motor, 200-steps-per-revolution, 5 mm shaft diameter, 12 V motor, each step turns the shaft only 1.8° for a full step, or 0.9° in half-stepping mode. This sized of motor is suitable for household appliances and industrial control applications. The stepper motor driver is L298N and is also connected to the controller which supplies the right operating current to the electric motors under load. In the sensing unit, the light dependent resistor is used to sense when the pounding chamber becomes dark (closed), giving a higher resistance output value than when in daylight. A torque sensor is made to sense when the stirring force of the stirrer remains constant and this information is used by the microcontroller to bring the process to a stop. The actuating unit is made up of two steppers motors (1.5hp), one motor provides the drive for the pounding assembly which is the scotch-yoke mechanism and the other motor drives the stirrer assembly. They are actuated in turns by the microcontroller in order to achieve a uniform texture of the pounded material. The design is modelled in two ways: the mechanical and the electrical.

2.1 Mechanical Model of the Enhanced Automatic Yam Pounding Machine

Pounding force P_f exerted by the pounder assembly;

$$P_f = P_p \times A \quad (1)$$

But, P_p is the pounding pressure

$$P_p = \rho_p \times g_p \times h_p \quad (2)$$

(Density of ply-wood = 680kg/m³)

Acc. Due to gravity = 9.81m/s²,

height of pounder = 0.15m)

The value for this design were not selected at random rather, they consist of two constant values and a measured value. The constants have been clearly stated, thus.

Therefore, pounding pressure P_p is

$$P_p = 680 \times 9.81 \times 0.15 = 1001\text{N/m}^2$$

$$\text{Area of the pounder base (A)} = \pi r^2 \quad (3)$$

$$r = 0.11\text{m}$$

Therefore,

$$\begin{aligned} P_f &= P_p \times \text{Area of pounder surface} \\ &= P_p \times \pi r^2 = 1001 \times 3.142 \times (0.11)^2 = 38.06\text{N} \end{aligned} \quad (4)$$

The measured values were from the prototype and substituted into formula as stated.

The minimum torque was determined thus; Torque(T) required to drive the pounding mechanism;

$$\text{Torque (T)} = \text{Pounding force (P}_f\text{)} \times \text{pounder distance to motor's line of action} \quad (5)$$

$$T = 38.06 \times 0.15 = 5.71\text{Nm}$$

Now, power needed in the electromechanical system is obtained thus;

$$\text{Power (P)} = \text{Torque} \times \text{Angular speed } (\omega) \quad (6)$$

$$P = T \times \frac{2\pi N}{60} = 5.71 \times \frac{2 \times 3.142 \times 15}{60} = 5.71 \times 1.571 = 8.97\text{w}$$

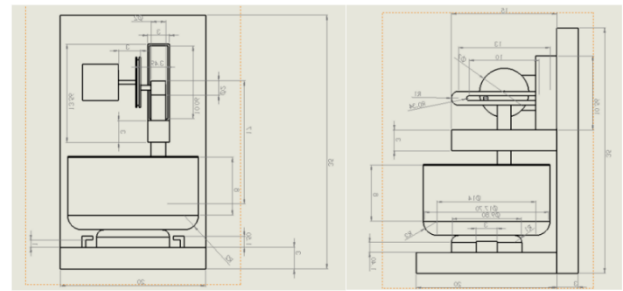

Figure 2: Orthographic projections of the Enhanced Automatic Yam Pounding Machine Model

Figure 2(a) represents the end view of the enhanced machine while Figure 2(b) represents the front view.

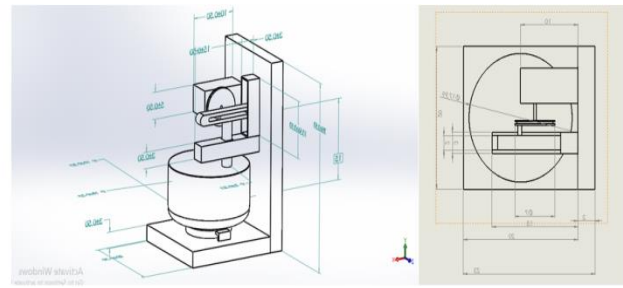

Figure 3: Isometric diagram of the Enhanced Automatic Yam Pounding Machine Model

Figure 3(a) shows the isometric projection of the enhanced automatic pounding machine while Figure 3(b) shows the plan for the orthographic projection in Figure 2.

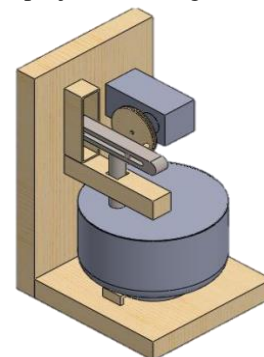

Figure 4: The model of the enhanced pounding machine

Figure 4 shows the model design of the enhanced automatic pounding machine produced using SolidWorks design software.

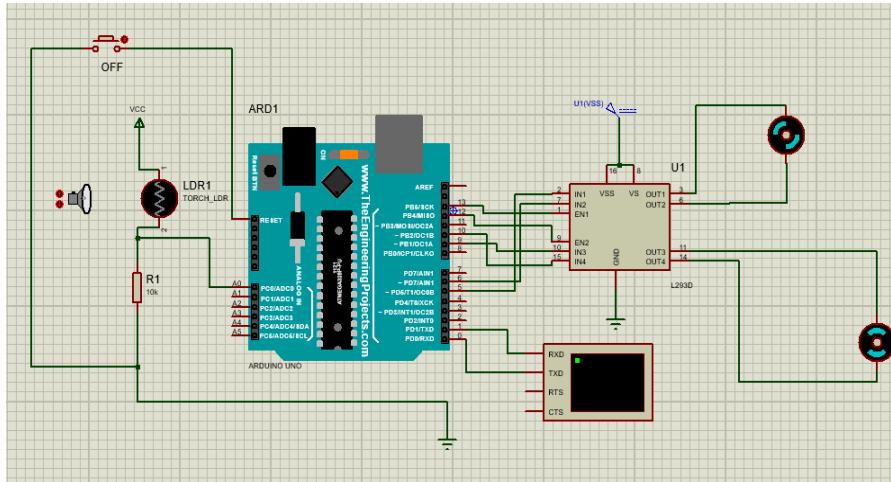

Figure 5: Electrical System Circuit of the Enhanced Automatic Yam Pounding Machine

2.2 Electrical Model of the Enhanced Automatic Pounding Machine

In Figure 5, the light dependent resistor senses when the pounding chamber is closed and the temperature of the pounding chamber is sensed to have increased instantly, the microcontroller uses the information to activate the process of yam pounding such that motor 1 initiates the pounding in vertical motion for 5 seconds before motor 2 is initiated to stir for another 5 seconds. This process repeats itself until when the torque sensor attached to motor 2 senses a constant torque value whereby the microcontroller initiates the stop action. The constant torque value to be obtained implies the absence of lumps in the processed yam. The 10W DC DC motors were adopted considering the calculated power rating in equation 6 which gave the 8.97watt as the minimum power needed by the electric motor to drive the pounding mechanism.

2.3 Pseudocode for the control program of the Enhanced Automatic Pounding Machine

```

Program begins
Initialise Outputs
    Motor 1;
    Motor 2;
    Light Emitting Diode 1;
    Light Emitting Diode 2;
Initialise Inputs
    Light dependent resistor value;
    Torque_value;
Function for the pounding operation
Read Initial temperature sensor value;
If Light dependent resistor value  $\geq 0.8M\Omega$ 
Read Final temperature sensor value;
If Final temperature sensor value - Initial temperature sensor
value  $\geq xxx$ 

```

```

    Switch ON Motor 1 for 5sec;
    Switch ON Motor 2 for 5sec;
else
    Switch OFF Motor 1 for 5sec;
    Switch OFF Motor 2 for 5sec;
Function for the Stirrer
Check torque value;
If torque value = constant for 10 sec [10];
    Switch ON Light Emitting Diode 2;
    Stop Motor2;
    Stop Motor1;
Break;
else
repeat "Function for the pounding operation";
end

```

3. Result, Discussions and Performance Evaluation

3.1 Mechanical Results of the Enhanced Automatic Yam Pounding Machine

The CAD designs produced from the Solidworks software as in Figures 2, 3 and 4 were considered for the fabrication of the prototype in Figure 6 and all the dimensions used were implemented. The hardware implementation of the Enhanced automatic yam pounding machine was carried out and the results of the fabrication are presented in Figure 6. Operations used to fabricate the prototype include marking out, cutting, smoothening, drilling and screwing.

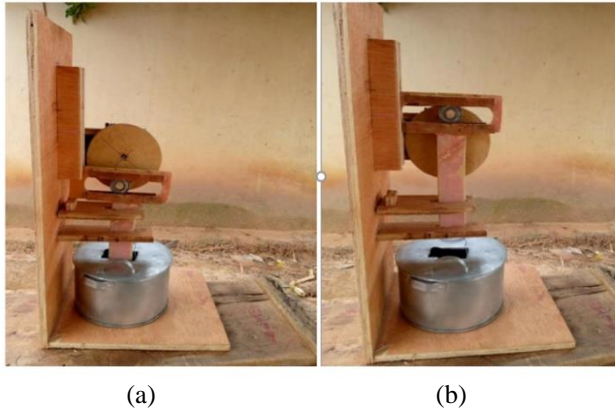

Figure 6: Yam Pounding Machine Prototype Model

The prototype of this design was fabricated from plywood and galvanized steel meanwhile the position of the vertical pounder is determined by the position of the bearing in the pounder slot that links the vertical pounder and the rotating disc. When the bearing is at 90° to the vertical as the disc rotates, the pounder begins to be lowered into the yam pounding chamber to crush the yam until the bearing reaches the lowest position and makes 90° to the horizontal as shown in Figure 6a before it continues its motion upwards. The pounder now rises gradually away from the yam pounding chamber vertically until the bearing reaches the highest position as shown in Figure 6b making a 90° to the horizontal.

3.2 Electrical Results of the Enhanced Automatic Yam Pounding Machine

The electrical design in Figure 5 was implemented and incorporated into the mechanical design in Figure 4, this brought about the prototype model in Figure 6. The results of the electrical implementation comprise of a table of values obtained using standard parameters of the motor and also a table of values obtained from the actual operation of the motor. The values and the plots are shown in tables 1 & 2 and Figures 7 & 8 respectively.

Table 1: Standard and Experiment Motor operation Values for the developed Model

	Speed (Rev/min)	Torque (Nm)	Power (WS)	Power (WE)
1	0	0	0.00	0
2	0	0.1	0.00	0
3	0	0.2	0.00	0
4	15	0.3	0.47	0.47
5	30	0.28	0.88	0.88
6	45	0.26	1.23	1.23
7	60	0.25	1.57	1.57
8	75	0.23	1.81	1.89
9	90	0.22	2.07	2.26
10	105	0.2	2.20	2.64

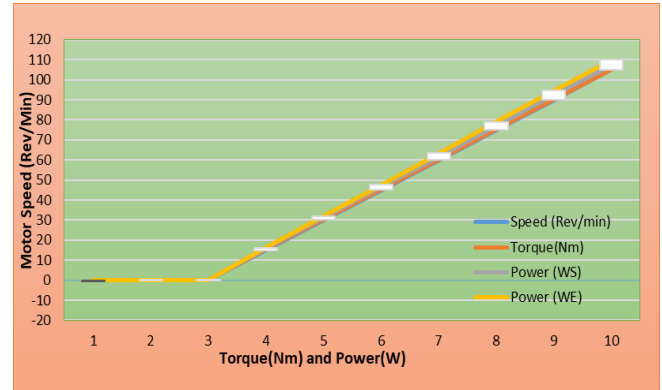

Figure 7: Standard and Experiment plot of the motor operation for the Enhanced Automatic Yam Pounding Machine

In Table 1 and Figure 7, the standard and experiment for the operations of the motor adopted for the implementation of an enhanced automatic pounding machine model were presented. This gives a detail of how the data and the plot are represented. PWS means Power gotten from the standard model and PWE means power gotten from the experimental model. Their details reveal that whenever there is a continuous gradual increase in the values of the speed and power of the motor, there is a decrease in the torque value.

The stepper motor used in this design has a rated holding torque of 0.31Nm and a detent torque of 0.016Nm. The experimental values were obtained from the actual operations of the motor. The torque, speed and power values designated (PWS) of the demonstrated prototype are presented in table 1 and Figure 7.

In this prototype demonstration again in table 1 corresponding to the plot in Figure 7 for the experimented power (PWE), the torque value of 0, 0.1 and 0.2Nm gives zero (0Rev/Min) of speed and zero (0W) of power. At torque values of 0.3, 0.28, 0.26 and 0.25 Nm gives a rise in speed and power to the magnitude of 15, 30, 45 and 60 Rev/Min, with the corresponding power of 0.47, 0.88, 1.23 and 1.57W respectively. This implies that the cooked yam is being processed. When the constant torque values of 0.24Nm was recorded against 75, 90 and 105 Rev/Min of speed, with the corresponding power values of 1.89, 2.26 and 2.64 W, it shows that the cooked yam has completely been processed and therefore the microcontroller initiates an action to bring the process to an end as provided by the pseudocode for this model. This is in validation of the model prototype performance in correspondence with table 1 and Figure 7 being the standard model parameter for a functional motor operation. Also, an introduced innovation into the existing automatic yam pounding machines which were only designed to pound yam, this design incorporates an additional motor to execute a stirring operation which is the prime function of the torque parameter introduced in this design model.

4. Conclusion

The enhancement was introduced into the automatic yam pounding system, the fabrication was successful as modelled. The enhanced yam pounding machine was designed as an electromechanical system using Proteus and Solid works software, and was fabricated using electrical components and the mechanical prototype developed. The test from the developed prototype reveals that between 0 to 0.29Nm torque did not produce any speed and power corresponding values. This implies the system is not in motion, however, at the torque of 0.3 to 0.25Nm, it gave the speed values of 15 to 60 Rev/Min with the corresponding power values of 0.47 to 1.57W. This implies that the machine is in operation until when the torque value reduces to constant 0.24Nm but the speed and the power values keeps on increasing to the magnitude of 75 to 105Rev/Min with the corresponding power values of 1.89 to 2.64W. This implies that the model has completed the processing task. With this, the automatic yam pounding machine has been enhanced.

References

- Chaturvedi, K., Dubey, M., Ghadigaonkar, S., & Gupta, V. (2018). Design and Development of Lever Engine based Pounding Machine. *International Journal of Scientific & Engineering Research*, 9(3), 6–10.
- Eker, B., & Icoz, A. (2017). Quality-Based Solutions in Food Industry Machinery. 2nd International conference on Quality of Life, Center for Quality, Faculty of Engineering, University of Kragujevac June 2017, 281–286. *Engineering Sciences*, 6(1), 1-8. DOI: 10.33552/GJES.2020.06.000631.
- Ikechukwu, G. A., & Muncho, M. J. (2015). Development of a motorized yam pounding machine design to improve standard of living for sustainable economic development in Nigeria. *Proceedings of the World Congress on Engineering 2015*, 2218, 984–988.
- Mishev, G. (2006). Analysis of the Automation and the Human Worker, Connection between the Levels of Automation and Different Automation Concepts. *Industrial Engineering and Management*, 1(22), 1–69.
- Nweke, F. I. (2019). Obstacles to Improvement in Rudimentary West African Yam Food Technologies : A Synthesis. *Food & Nutrition : Current Research*, 2(2), 155–157.
- Oisehoemomen, I., Essien, A. and Adesuji, A. (2020). Development of a Modular and Sustainable Yam Pounding Machine. *Global Journal of*
- Onuoha, S.N., Atanda, E.A. & Unuigbo, M. O. (2019). Design, Fabrication and Testing of Yam Pounding Machine. *Journal of Mechanical and Civil Engineering*, 16(1), 68–78. <https://doi.org/10.9790/1684-1601056878>
- Oyeyemi, A., Jajimaji, F., Oyeyemi, A., & Jabbo, A. H. (2017). Cardiovascular responses to millet pounding activity among women in a rural community in Northeastern Nigeria. *Annals of African Medicine*, 16(1), 24–29. <https://doi.org/10.4103/1596-3519.202090>
- Puoza, J. C., Opoku, F., & Aboagye, B. (2016). Development and testing of a motorized cassava fufu pounding machine. *International Journal of Engineering and Technology (UAE)*, 5(1), 1–6. <https://doi.org/10.14419/ijet.v5i1.5155>
- Sani, M. S., & Aziz, F. A. (2013). Advanced manufacturing systems in food processing and packaging industry. *IOP Conference Series: Materials Science and Engineering*, 46(1), 1–9. <https://doi.org/10.1088/1757-899X/46/1/012042>
- Uchenna, O. B., Chuka, C. E., Daniel, E. C., & Efofa, O. (2015). Design, fabrication and characterisation of an electric powered yam pounding machine. *American Journal of Mechanical Engineering and Automation*, 2(2), 26–35.
- Yohanna, M. D. (2019). Design and Modification of a Yam Pounding Machine. *International Journal of Science and Research*, 8(9) , 379–382.