

SPATIAL MODEL OF PUBLIC NON-IONIZING RADIATION EXPOSURE ON SELECTED BASE STATION AROUND KUALA NERUS

A. R. S. N. Dianah¹, S. N. Hazmin^{1,*}, R. Umar², H. Jaafar³, M. K. A. Kamarudin², A. N.
Dagang⁴ and H. N. Syafiqah^{1,2}

¹School of Fundamental Science, Universiti Malaysia Terengganu, 21030 Kuala Terengganu,
Terengganu, Malaysia

²East Coast Environmental Research Institute (ESERI), Universiti Sultan Zainal Abidin, Gong
Badak Campus, 21300 Kuala Nerus, Terengganu, Malaysia

³Faculty of Electrical Engineering, Universiti Teknologi MARA, 23000 Dungun, Terengganu,
Malaysia

⁴School of Ocean Engineering, Universiti Malaysia Terengganu, 21030 Kuala Terengganu,
Terengganu, Malaysia

Published online: 15 January 2018

ABSTRACT

Although it is not as intense as in other countries around the world, Malaysia is not left out to enhance the rapid development of technology by installing thousands of base station tower as an initiative to support the advancement of technologies nowadays. The construction of more base stations tower either for telecommunication, broadcasting or other systems has caused public concern about the possibility of adverse health effects on residents nearby due to NIR exposure emitted. This study is conducted to study the NIR exposure level around selected BST in Kuala Nerus. The NIR exposure level was detected using spectrum analyzer through circular patch (CP) antenna, which is specifically developed for this study. Spatial model of NIR exposure was developed using Geographic Information System (GIS) technique so the interpretation of NIR exposure level from BST for Kuala Nerus can be obtained.

Keywords: public exposure; Geographic Information System; base station tower.

Author Correspondence, e-mail: norhazmin@umt.edu.my

doi: <http://dx.doi.org/10.4314/jfas.v10i1s.37>



1. INTRODUCTION

Electromagnetic radiation (EMR) is only a kind of energy emitted from a source that can travel through a vacuum at the speed of light, which is also can be described in terms of its frequency and wavelength. Theoretically, the higher frequency with the shorter wavelength of waves propagates will carry the higher energy. All objects warmer than absolute zero (-273°C) emit electromagnetic radiation (EMR) [1]. Since EMR is kind of energy, so that it can be reflected, refracted, transmitted or absorbed through any medium by depending on the conductivity of the exposed medium and the frequency of the field.

Naturally, the human body is capable of responding to the energy by absorbing, storing, use and release in their daily activities. Since EMR also is a kind of energy, thus, it can be absorbed by human body, penetrate through the skin and further penetrate into the cell body. In a medical study reported thermal energy transferred by EMR that penetrate into the cell body can cause the deoxyribonucleic acid (DNA) damage and trigger cell cancer due to the response of human body cells to the fluids in the body [2]. That is why human skin that exposed to the radiation will be irritated [3]. As shown in the electromagnetic spectrum, EMR is classified into two major types which Non-ionizing Radiation (NIR) and Ionizing Radiation (IR). The differences between these radiations: IR is the high frequency (short wavelength) has enough energy to produces ions (ionizing process) while NIR which is the low frequency (longer wavelength) does not have enough energy to go through the process of ionization [4]. However, NIR is very close to human life since it sourced from all electrical appliances around us such as microwave oven, computer and laptops, heater, television and many more. Our daily life are depends heavily on these kind of technology so we are prone to this kind of radiation. Some studies proved that without public awareness, the long-term adverse effects from NIR emitted may be occurred [2].

Rapid development in wireless technology has led to an increase of the installation of BST around the public places and residential area. Thus, high quality of signal coverage can be provided [5]. However, there are rumours that the construction of BST close to residential area may cause the possibility of negative effects on residents nearby due to the NIR emitted. Therefore, mobile phone users were exposed to the both mobile phone and BST radiation [2].

Even worse, they will be exposed to these radiations for a long period so the probability to suffer the long-term adverse health effect is high.

The use of mobile phones, electronic gadget and other electrical appliances, however, can be controlled with user initiatives. In contrast, the level of exposure from BST is beyond our control and the radiation will always be emitted regardless of the usage. Besides, the exposure levels in the vicinity of BST were found 10,000 to 10,000,000 times stronger than area far away from BST [5]. Thus, it is crucial to study the exposure level from BST as the precautions for nearby residents as it may harm to human health. There are numerous studies on the NIR exposure level assessment conducted recently and found that the radiation levels are well below the guidelines limit recommended by International Commission on Non-ionizing Radiation Protection (ICNIRP) [5]. According to the findings of recent studies, there are several factors influence the NIR exposure level around the BST area such as the distance and the height of the BST, the number of antennas on single BST, tilt and the direction of the antennas and also its direction of main beam radiation. The line of sight (LOS) path is also play the role in contributing to the level of exposure. The signal strength may be disturbed if the transmission path of the radio signal from BST does not propagate in LOS path due to the existence of any obstruction such as physical objects which not only may exist as buildings but also trees, hills or mountains around the BST [2, 5, 29].

In this study, GIS technique was used to develop a spatial model of public NIR exposure on selected BST around Kuala Nerus with the electric field strength data as a parameter for evaluating the exposure level emitted. Nowadays, GIS is becoming more popular and have been applied as an essential role to help users in collecting, capturing, storing, processing, manipulating, analyzing, managing, retrieving and display data or information which is essentially, referenced to the real world [6-9]. Geographic information system (GIS) technology is an example of graphical or spatial method that suitable use in scientific investigations, resource management and development planning such in geography, the environmental sciences and computer science area studies [10]. The advantages of GIS are allows and help people to know about specific information of location and to analyze the related spatial data and display data in different formats [11-12].

Besides that, users usually used GIS to compare the locations in different characteristics in order to study the relationship between them. GIS has been used by other researchers in EM pollution studies to provide the useful information besides analyze and explain the level of EM pollution and probable health problems around study sites [6-8, 10, 14-17]. Therefore, the NIR exposure model of this study can be used to get a clearer view of NIR exposure around Kuala Nerus. Thus, will provide early stage information for the development of public radiation exposure policy to Malaysian government for health concern.

2. RESULTS AND DISCUSSION

2.1. NIR Exposure Level Measurement and NIR Sources Identification

In this study, the measurements of NIR exposure levels was done in terms of electric field (EF) strength. The measurements have been carried out around three selected BST in Kuala Nerus based on different category of area which are sub-urban and rural area (Fig. 1).

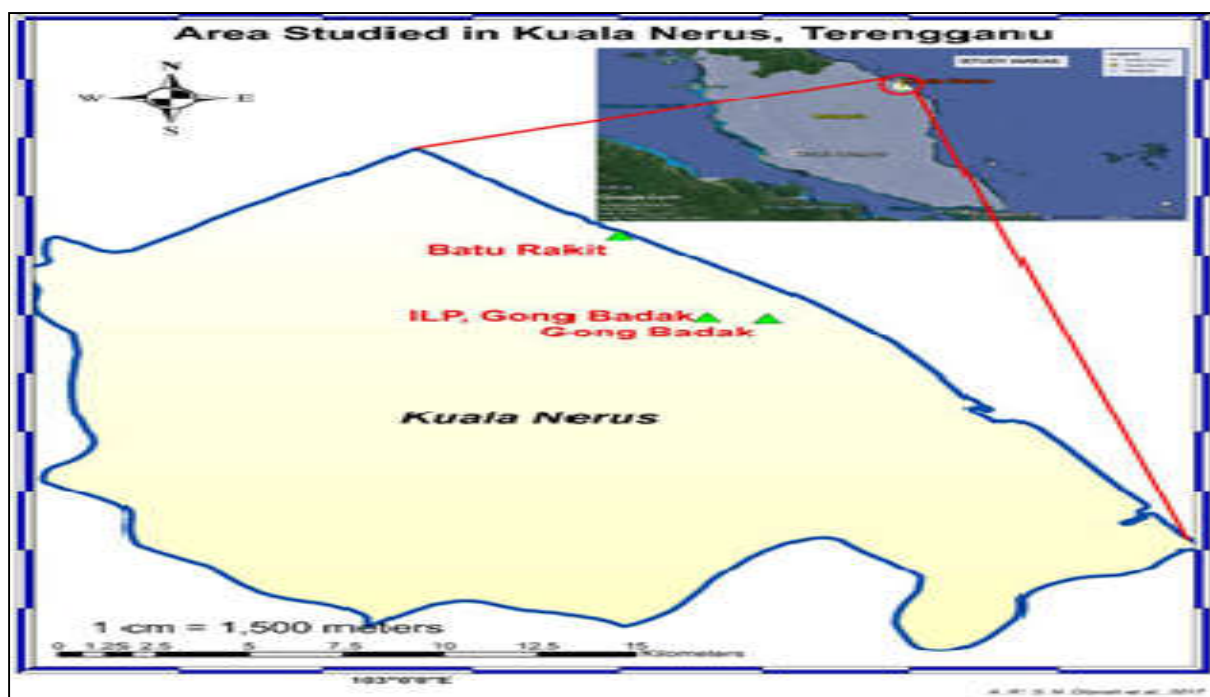

Fig.1. Selected BST areas studied in Kuala Nerus, Terengganu

The EF strength received at a given distance is crucial in radiation exposure level assessment. The average of EF strength measured around each of BST are shown in Fig. 2 between frequency range 67.5 MHz up to 3 150 MHz, which is part of the radiofrequency (RF) range.

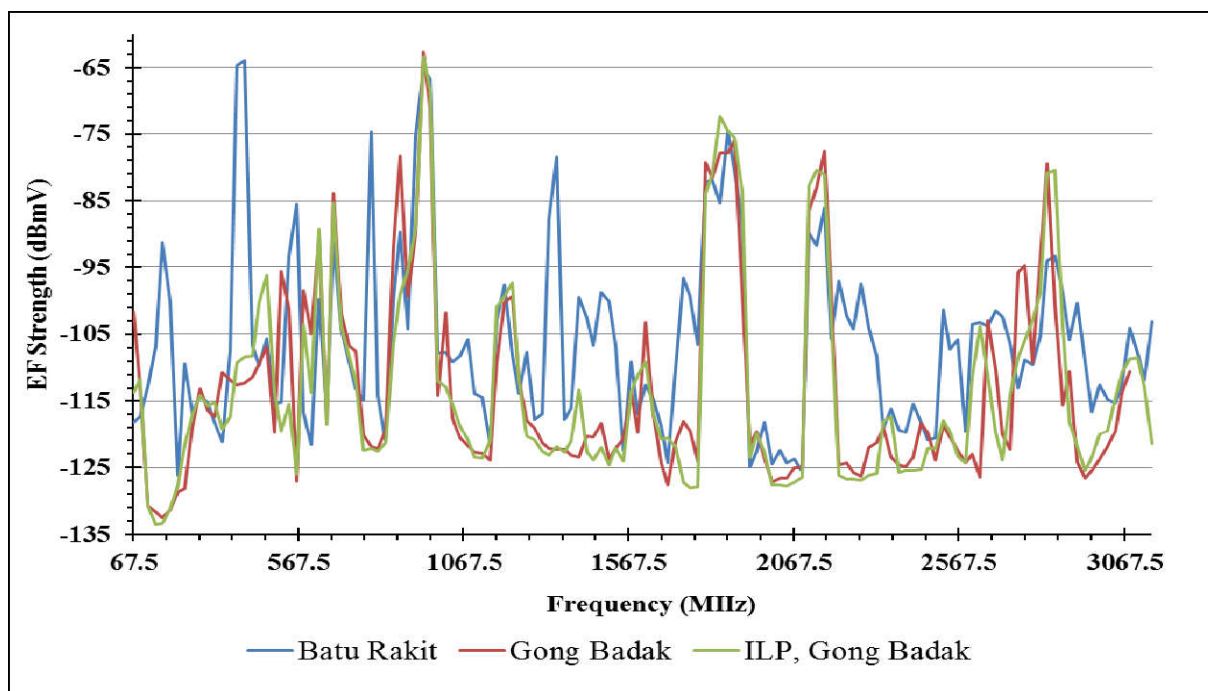

Fig.2. The measured EF strength around each BST area

Based on Fig. 2, it can be seen that EF strength are in different power level for different frequency. This is because the different frequency peaks were represented the different radiation sources that were existed around the measurement site. Referring to the allocation spectrum plan reproduced by Malaysian Communications and Multimedia Commission (MCMC) with the permission of International Telecommunication Union (ITU), the sources of the highest frequency peaks detected around each of BST areas as shown in Fig. 1 were listed in Table 1.

Table 1. The highest frequency detected around each BST area [5, 18]

Frequency (MHz) detected	Frequency Band (MHz)	Sources	BST Location		
			Batu Rakit	Gong Badak	ILP, Gong Badak
157.5	156.8375-161.9625	<ul style="list-style-type: none"> Maritime Mobile Services Digital Broadcasting Service 	√		
382.5	335.4-387	<ul style="list-style-type: none"> Public Protection and Disaster Relief (PPDR) in Malaysia 	√		

		<ul style="list-style-type: none"> • Land Mobile Radio Equipment • Mobile • Supervisory Control and Data Acquisition (SCADA) and telemetry • Meteorological Aid Service • Digital Terrestrial Television (DTT) 	√		
405	403-406				
472.5	470 – 512	<ul style="list-style-type: none"> • The analogue television (TV) broadcasting stations • DTT Broadcast Receiver • IMT (450 MHz to 470 MHz) 			√
540		<ul style="list-style-type: none"> • Personal radio service device • Land Mobile Radio Equipment 	√		
562.5	512 – 585	<ul style="list-style-type: none"> • Short Range Devices • Digital Broadcasting 	√		
630		<ul style="list-style-type: none"> • Digital Broadcasting Service • Broadband Wireless Access (BWA) 		√	√
675	614 – 698	<ul style="list-style-type: none"> • The analogue TV broadcasting • DTT Broadcast Receiver • DTT 	√	√	√
787.5	698 – 790	<ul style="list-style-type: none"> • BWA • The analogue TV broadcasting 	√		
855	806 – 862	<ul style="list-style-type: none"> • DTT Broadcast Receiver 			√

		• Digital Terrestrial Television			
877.5	862 - 890	• Mobile (IMT)	√	√	
		• Broadcasting			
922.5	902-928	• Mobile (GSM 900)	√	√	√
945	942-960	• Broadcasting	√	√	√
		• Aeronautical Radionavigation			
967.5	960-1164	• Aeronautical Mobile	√	√	√
1327.5		• Aeronautical and Radiolocation	√		
		Radionavigation			
	1300-1350				
1350		• Radionavigation	√		
		• Satellite (Earth-to-space)			
1800			√	√	√
1822.5		• Mobile (GSM 1800)	√	√	√
1845		• Mobile (UMTS 2100 and		√	√
1867.5	1710 –1930	IMT 2000)	√	√	√
1890			√	√	√
1912.5			√		√
		• Mobile (UMTS 2100)			
		• IMT-2000 Third-Generation			
		(3G) Cellular Mobile Terminals			
2115	2110-2120	(SKMM WTS IMT-MT)	√	√	√
		• Space Research-deep space			
		(Earth-to-space)			
2137.5		• IMT-2000 Third-Generation	√	√	√
		(3G) Cellular Mobile Terminals			
2160	2120-2160	(SKMM WTS IMT-MT)	√	√	
2767.5		• Aeronautical Radionavigation		√	
2812.5	2700-2900	(restricted to ground-based		√	
2835		radars and to associated airborne	√	√	√

	transponders)		
2857.5	• Radiolocation radars used for meteorological purposes)	(ground-based)	√ √

Source: International Mobile Telecommunications (IMT), Global System for Mobile (GSM), Universal Mobile Telecommunications System (UMTS).

From Table 1, the sources detected around the BSTs area are mostly sourced from the BST such as mobile, broadcasting, and radio transmitter. Other sources are from personal radio service device and land mobile radio equipment. Based on Fig. 2, frequency peak 945 MHz shows the highest value of EF strength for all sites measurement. The higher signal power transmitted from all BST not only contributing to the high-quality of service coverage in telecommunication but also contributing to the level of NIR exposure to surrounding. It was found that GSM 900 and other communication systems such GSM 1800, UMTS 2100 and IMT as the main contributors to the NIR exposure level around BST area [5]. In [24] also mentioned that transmitter GSM 900 system is often installed more in rural areas, meanwhile GSM 1800, UMTS/GSM 2100 and IMT communication system are installed more in denser populated area [5].

The EF strength of all selected sites measurement are found to be well below the limits even for the maximum exposure levels [19-20, 49-50]. Even though the exposure level does not exceed the limit guidelines, but a repetitive exposure to NIR can cause common health effects such headaches, insomnia, cancer and also reproductive system [2]. Other than that, long duration exposure of high frequency which causes the rising temperature can trigger heat stroke and burning of tissue besides causes the changing of Deoxyribonucleic Acid (DNA) structure [2]. This effect called as thermal effect.

The measurement of EF strength for all BSTs are performed at distance 0 m (nearest), 50 m, 100 m, 150 m, 200 m, 250m, 300 m and 350 m from the BST. The measurement set up is as shown in Fig. 8. The trend of EF strength against the distances has demonstrated in Fig. 3.

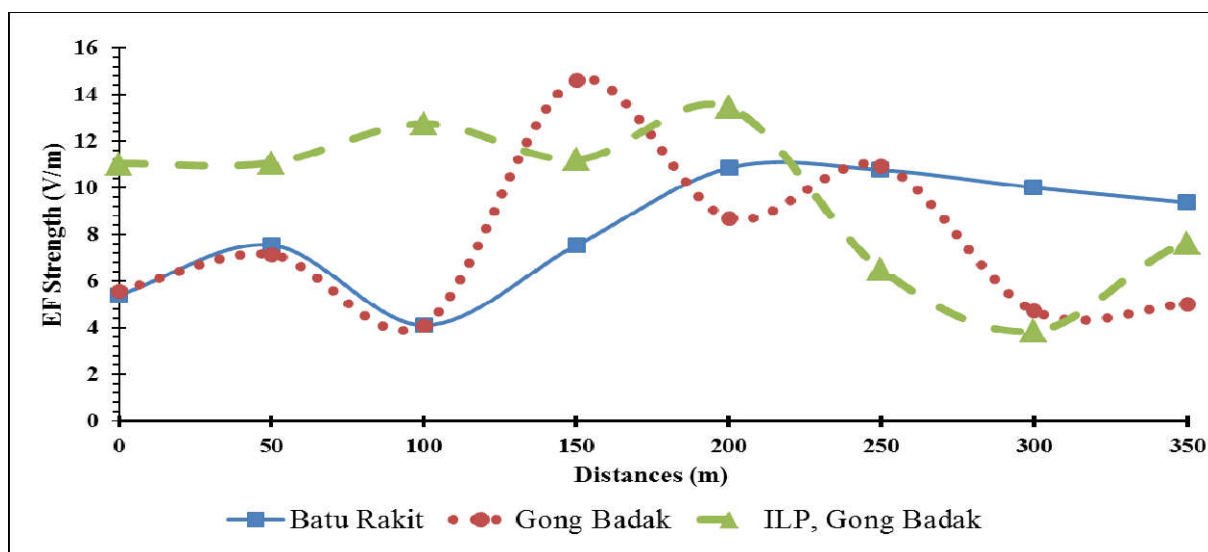

Fig.3. Trend of EF strength measured against distances from BSTs

Overall, a great variation of exposure level trend at every distance for each site can be observed in Fig. 3. Theoretically, all of the EMR sources obey the inverse-square law that means the intensity or strength of EMR exposure source is inversely proportional to the square of the distance from the source [2, 21-23]. This is due to the surface of the transmission area increases with the square of the distance. However, the exposure level also can be influenced by other factors that will cause the exposure level keep changing or fluctuating along the measurement path.

The main factors that has been said to affect the level of EF strength are the main beam of the radiation pattern emitted from the BST antennas and the obstruction existence around the measurement site [2, 5]. Usually exposure level measured directly under the BST has low radiation level exposure, but BST cannot be in zero values due to the side beam of the BST antennas besides existence of other sources nearby. The exposure level will start to increase at distance about 10 m to 50 m from BST antennas then achieve the highest level usually at distances 50 m to 300 m since the emitted main beam of the radiation pattern reached the ground level [2]. The exposure radiated from transmitting antenna expected to be higher at the main beam coverage and expected to be lower when further away from the main beam called as side beam [24]. In addition, the main beam emitted from the BST antenna is depending on its tilt. The higher degree of depression angle (looking down), the nearer the main lobe to BST foots. Therefore, the highest exposure level for each site is different depending on the tilt of

the antennas installed on top of the BSTs and thus become one of the side factors that affects the exposure level.

The result obtained based on Fig. 3 has strengthened the previous study by showing the same trend: low exposure level when nearest to the BST and started to shows the increment up to about 50 m, then reached the highest exposure level at distance 100 m from the BST and shows the decrement at distance about 200 m. Thus, in this study, it can be concluded that the EF strength sourced from the BST does not obeys the inverse-square law due to the factors as mentioned previously.

However, the EF strength of exposure can still follow the inverse-square law when the RF signal transmitted from BST transmitter antennas travel in a direct LOS path without any obstruction. So that, the existence of obstructions around the BST area also can be the main factor affecting the exposure level at the area [2, 5]. The obstruction may exist as any physical objects for example buildings which also depend on the electrical properties of a material of the building's construction which can cause reflection, diffraction and diffusion of signal propagation that can cause the attenuation of exposure level to occur [2]. According to the past research analysis, the RF signal which do not travels in LOS path has shown the sharp declination trends due to the buildings nearby [2, 25]. Besides, the fluctuation of EF strength as shown in Fig. 3 probably due to other radiation sources nearby.

2.2. Public NIR Exposure Spatial Model

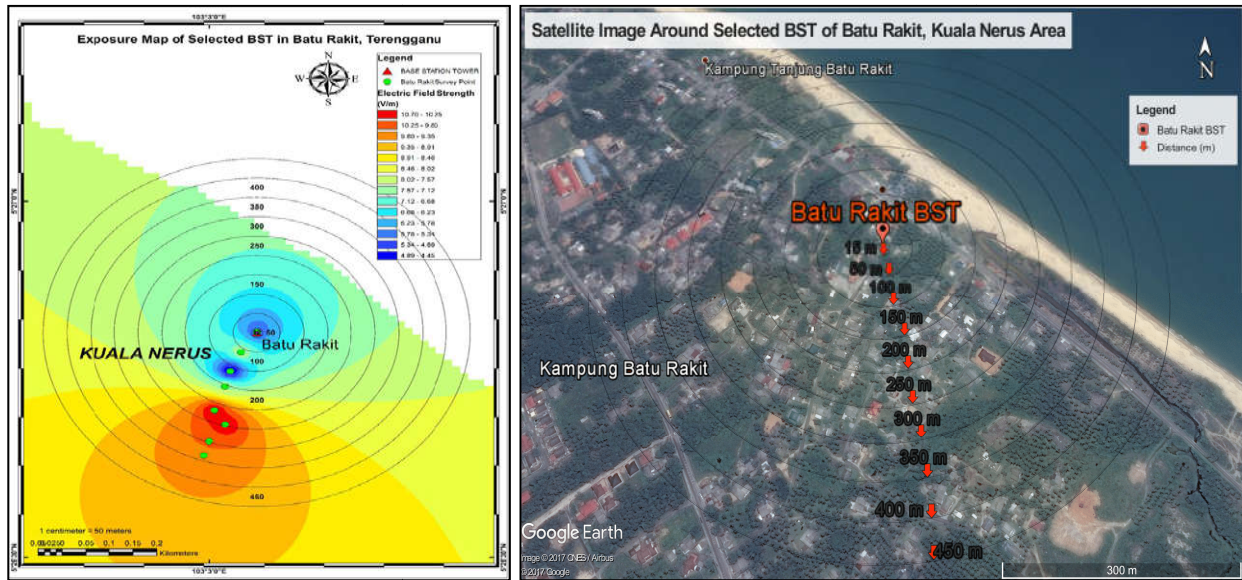

(a)

(b)

Fig.4. Selected BST area in Batu Rakit, Kuala Nerus. (a) Spatial model, (b) Satellite image

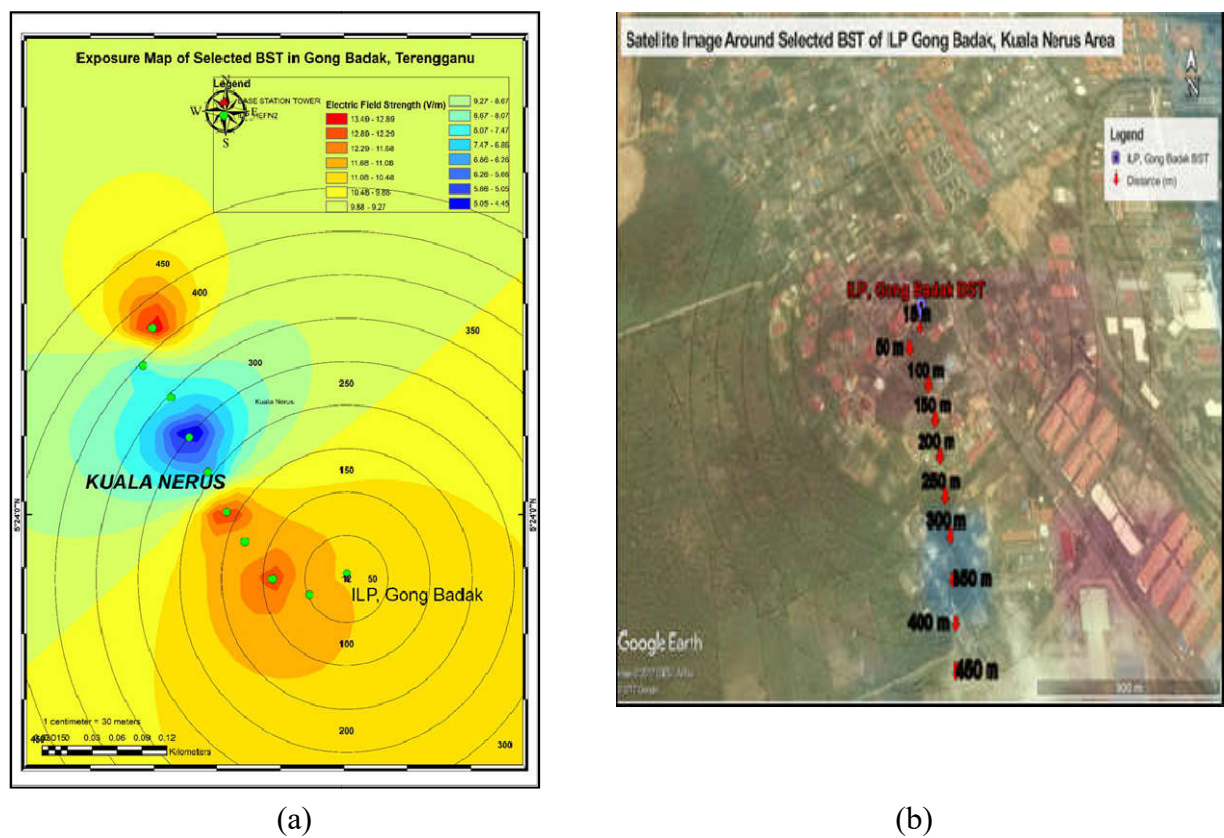

(a)

(b)

Fig.5. Selected BST area near to ILP Gong Badak, Kuala Nerus. (a) Spatial model, (b) Satellite image

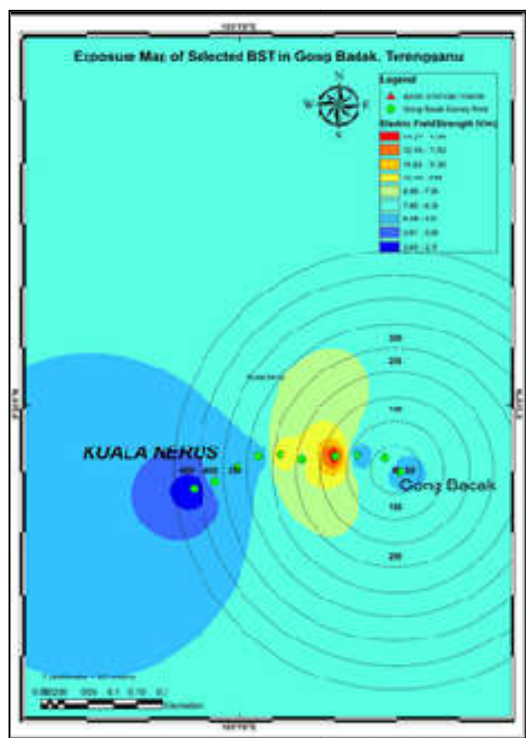

(a)



(b)

Fig.6. Selected BST area in Gong Badak, Kuala Nerus. (a) Spatial model, (b) Satellite image

From the dataset obtained in this study, a spatial model of public NIR exposure has been developed as shown in Fig. 4-6 to visualize the NIR exposure level around the selected BST areas, besides, to identify the differences of the study areas which probably give the dissimilar findings. These spatial models have been developed using GIS [27] technologies (ArcGIS 10.2 software) in order to get a clearer view to observe either the public area such residential area, the number of mobile phone user or other factors around the selected BST area that possible to contribute to the public NIR exposure.

As illustrated in figures above, by using the IDW interpolation method, the distribution of NIR exposure level can be seen clearly by the indication used where the highest exposure with dark red color and down to the medium exposure with yellow color then the lowest exposure with dark blue color. Based on the comparison for all the three study areas, it was found that BST area in Batu Rakit has the higher exposure (Fig. 4). Although the satellite image shown the less dense area for the Batu Rakit site, the less obstruction around the BST area make the signal transmitted in LOS path over the area. It can be concluded that the

reflection, diffraction and diffusion of signal propagation less to occur, so that path loss of the power transmitted from transmitter to receiver is reduced. Furthermore, the highest exposure at distance 250 m to 350 m probably due to the existence of another four BSTs nearby in Batu Rakit. Thus, it will enhance the exposure level around this study site which it is possible due to the constructive signal wave to occur when the interfering signal and the transmitting signal are in the same or nearly same frequency [26]. Meanwhile, the best site with the least exposure to NIR as in Fig. 6 was found at the dense area which is at Gong Badak site probably due to the power transmission loss to occur.

Next, for the NIR exposure level at selected BST area near to the *Institut Latihan Perindustrian* (ILP), Gong Badak shows the quite higher exposure possibly due to that area has been known as an industrial area (Fig. 5). As we already know there is many heavy machinery or electrical appliances with high voltage used in the industrial area. In addition, there are also other surroundings factors that can affect the NIR exposure level of an area such as mobile phone users or moving vehicles.

Therefore, can be concluded that there are many factors that might be influence the NIR exposure. For example the facing of the main beam radiation emitted from BST antennas (tilt of antenna), LOS path, height of antenna and other radiation sources exist at surroundings.

3. METHODOLOGY

3.1. Equipment and Study Area

Three BST sites around Kuala Nerus were selected in this study based on different category of area which are sub-urban and rural area where located at east coast region of Malaysia (Fig. 1 and Table 2).

Table 2. Location of NIR exposure level measurement around Kuala Nerus, Malaysia

Sites	Location	Latitude (N)	Longitude (E)	Category of Area
BST 1	Gong Badak	5°23'55.5"	103°5'10.8"	suburban
BST 2	ILP, Gong Badak	5°23'57.8"	103°4'18.5"	suburban
BST 3	Batu Rakit	5°26'49.0"	103°3'3.1"	rural

Basically, such in this study, there are two main components required to measure the exposure level of a source which is a receiving antenna used to capture signal from the source and spectrum analyzer (SA) is used to display exposure readings in terms of voltage amplitude (dBmV). Omnidirectional CP antenna [30] was constructed as a receiving antenna specifically for this study and the spectrum analyzer model used is Keysight N9915A, USA. The instrument is set up as shown in Fig. 8.

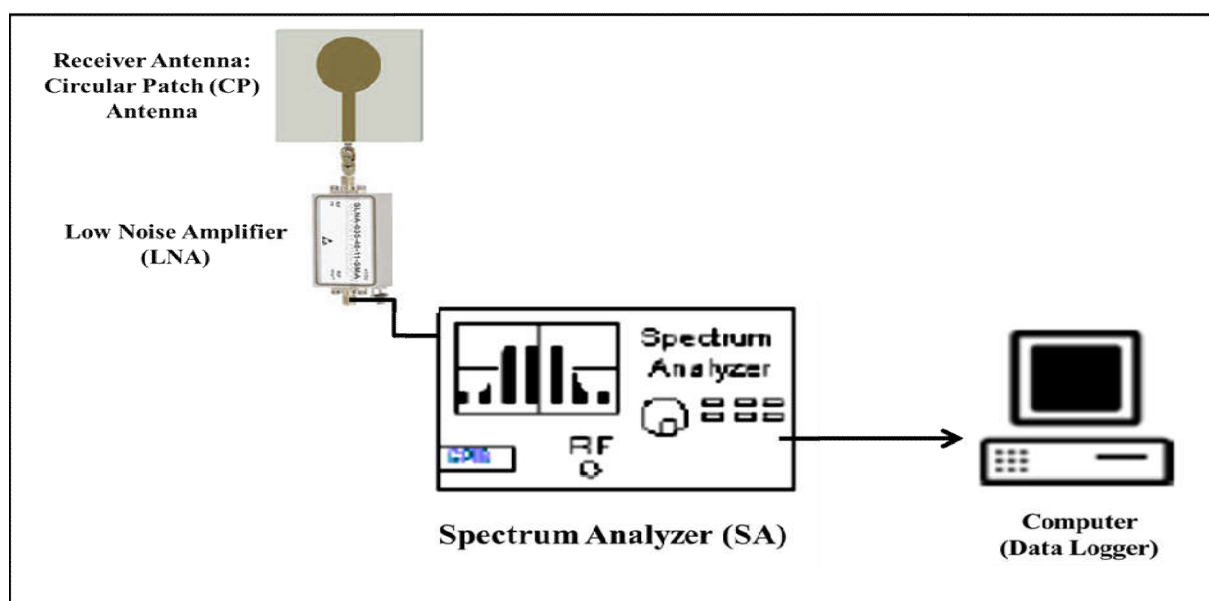

Fig.8. Measurement set up

The instrument was installed at distance of 15m, 50m, 100m, 150m, 200m, 250m, 300m and 350m from BST. Then, SA is set to SA mode and readings are taken for 10 minutes for each distance. The coordinates of measurement sites for each distance were recorded through a Global Position System (GPS) for the mapping process. After that, the reading obtained was extracted from SA to the computer for further analysis. Lastly, the data is needed to key in into the ArcGIS software for mapping purpose.

3.2. Spatial Model Analysis

In this study, the tools use for spatial model analysis is the Inverse Distance Weighted (IDW) interpolation and Multiple Ring Buffer. The IDW interpolation is used to interpolate the EF strength data according to the geographical location. Whereas, the Multiple Ring Buffer tool is used to represents the distance measured from the BTS points. Both techniques then were layered and act as exposure map in order to determine the relationship between the exposure

level of BST and the distance measured. Next, the exposure map was compared to the satellite image of the study area in order to study the other surrounding factors which might be influenced the NIR exposure level.

4. CONCLUSION

The objective or goal of this research is to develop a public NIR exposure on selected BST area around Kuala Nerus. Besides, to study how several factors such as the main beam of BST, LOS path and other sources influence the NIR exposure level surrounding the BST area. This study also was done by comparing the EF strength measured with ICNIRP standard limit and resulted well below the standard limit. However, the long-term of NIR exposure can produce the same effect as short-term exposure of higher level in long-term effect. Therefore, this spatial model can be used to get a clearer view of NIR exposure besides providing the early stage information about public NIR exposure as a guide to take seriously in monitoring radiation [28] exposure level. Thus, health risks can be reduced as much as possible.

5. ACKNOWLEDGEMENTS

This study is made possible by the usage of grant FRGS/1/2015/SG02/UNISZA/02/1, TPM 68006/2016/79) and UMT 68006/INSENTIF/60. The authors also thank to Universiti Malaysia Terengganu, Universiti Sultan Zainal Abidin and Universiti Teknologi MARA for the facilities provided.

6. REFERENCES

- [1] Ahrens C. D., Henson R. Meteorology today. Massachusetts: Cengage Learning. 2016
- [2] Dianah A R, Hazmin S N, Umar R, Kamarudin M K, Dagang A N. A review on electromagnetics (EM) exposure measurement techniques from base station. Journal of Fundamental and Applied Sciences, 2017, 9(2S):182-98
- [3] Hardell L, Sage C. Biological effects from electromagnetic field exposure and public exposure standards. Biomedicine and Pharmacotherapy, 2008, 62(2):104-109

-
- [4] Dawoud M M. High frequency radiation and human exposure. In International Conference on Non-Ionizing Radiation, 2003, pp. 1-7
- [5] Dianah A R S N, Hazmin S N, Umar R, Kamarudin M K A, Dagang A N. Exposure level from selected base station tower around Kuala Nerus: A preliminary analysis. *Journal of Fundamental and Applied Sciences*, 2017, 9(5S):367-380
- [6] Durduran S S, Uygunol O, Seyfi L. Mapping of electromagnetic pollution at 1800 MHz GSM (global system for mobile communication) frequency in Konya. *Scientific Research and Essays*, 2010, 5(18):2664-2672
- [7] Al-Akhras M A, Albiss B A, Alqudah M S, Odeh T S. environmental pollution of cell-phone towers: Detection and analysis using geographic information system. *Jordan Journal of Earth and Environmental Sciences*, 2015, 7(2):77-85
- [8] Moraru L, Marica L. Necessity of GIS system for electromagnetic field management in Galati. *Journal of Science and Arts*, 2011, 1(14):85-90
- [9] Sen A, Gümüşay M U, Kavas A, Bulucu U. Programming an artificial neural network tool for spatial interpolation in GIS-A case study for indoor radio wave propagation of WLAN. *Sensors*, 2008, 8(9):5996-6014
- [10] Gumusay M U, Sen A, Bulucu U, Kavas A. Electromagnetic coverage calculation in GIS. In International Symposium on Mobile Mapping Technology, 2007, pp. 1-6
- [11] Kamarudin M K A, Toriman M E, Rosli M H, Juahir H, Aziz N A A, Azid A, Zainuddin S F M, Sulaiman W N A. Analysis of meander evolution studies on effect from land use and climate change at the upstream reach of the Pahang River, Malaysia. *Journal Mitigation and Adaptation Strategies for Global Change*, 2015, 20(8):1319-1334
- [12] Mustafa A D, Azid A, Juahir H, Amran M A, Kamarudin M K A, Gasim M B. Geographical Information System (GIS) for relationship between dengue disease and climatic factors at Cheras, Malaysia. *Malaysian Journal of Analytical Sciences*, 2015, 19(6):1318-1326
- [13] Ammoscato A, Corsale R, Dardanelli G, Scianna A, Villa B. GPS-GIS integrated system for electromagnetic pollution. In *The International Archives of the Photogrammetry, Remote Sensing and Spatial Information Sciences*, 2008, pp. 491-498

-
- [14] Nuckols J R, Ward M H, Jarup L. Using geographic information systems for exposure assessment in environmental epidemiology studies. *Environmental Health Perspectives*, 2004, 112(9):1007-1015
- [15] Rinaldi A M. GIS-based system for electromagnetic risk management in urban areas. *Journal of Location Based Services*, 2009, 3(1):3-23
- [16] Genc O, Bayrak M, Yaldiz E. Analysis of the effects of GSM bands to the electromagnetic pollution in the RF spectrum. *Progress in Electromagnetics Research*, 2010, 101:17-32
- [17] Harrison F, Burgoine T, Corder K, Sluijs E M Fvan, Jones A. How well do modelled routes to school record the environments children are exposed to?: A cross-sectional comparison of GIS-modelled and GPS-measured routes to school. *International Journal of Health Geographics*, 2014, 13:1-12
- [18] Malaysian Communications and Multimedia Commission (MCMC). Spectrum plan. Selangor: MCMC, 2014
- [19] International Commission on Non-Ionizing Radiation Protection (ICNIRP). Base station (high frequency): Characteristics of the application and its use. Oberschleissheim: ICNIRP, 2017
- [20] Telecommunication Standardization Sector of International Telecommunication Union (ITU-T). Recommendation K.52 (12/2004): Guidance on complying with limits for human exposure to electromagnetic fields. Geneva: ITU, 2014
- [21] Osepchuk J M. A review of microwave oven safety. *Journal of Microwave Power*, 1978, 13(1):13-26
- [22] Cooper T G, Mann S M, Khalid M, Blackwell R P. Public exposure to radio waves near GSM microcell and picocell base stations. *Journal of Radiological Protection*, 2006, 26(2):199-211
- [23] Ismail A, Din N M, Jamaluddin M Z, Balasubramaniam N. Electromagnetic assessment for mobile phone base stations at major cities in Malaysia. In 9th IEEE Malaysia International Conference on Communications, 2009, pp. 150-153

- [24] Buckus R, Strukčinskienė B, Raistenskis J, Stukas R, Šidlauskienė A, Čerkauskienė R, Isopescu D N, Stabryla J, Cretescu I. A technical approach to the evaluation of radiofrequency radiation emissions from mobile telephony base stations. *International Journal of Environmental Research and Public Health*, 2017, 14(3):1-18
- [25] Mahadi W N L, Ali N M, Wen Q P. Evaluation of RF EMF exposure pattern on selected communication towers in Malaysia. In *IEEE International Conference on Semiconductor Electronics*, 2010, pp. 344-347
- [26] Tse D., Viswanath P. *Fundamentals of wireless communication*. England: Cambridge, 2013
- [27] Kamarudin M K, Nalado A M, Kasmuri A, Toriman M E, Juahir H, Umar R, Jamil N R, Saudi A S, Rizman Z I, Gasim M B, Hassan A R. Assessment of river plan changes in Terengganu River using RS and GIS method. *Journal of Fundamental and Applied Sciences*, 2017, 9(2S):28-45
- [28] Taat A, Zakaria N A, Rahman A A, Jusoh M H, Rizman Z I. Variation of VHF/UHF of forward scattering radar due to solar radiation. *ARPN Journal of Engineering and Applied Sciences*, 2017, 12(10):3278-3284
- [29] Rizman Z I, Jusoff K, Rais S S, Bakar H H, Nair G K, Ho Y K. Microwave signal propagation on oil palm trees: Measurements and analysis. *International Journal on Smart Sensing and Intelligent Systems*, 2011, 4(3):388-401
- [30] Shafie R, Rizman Z I, Husin N H. Enhancement of microstrip circular patch antenna performances using DGS technique for wireless communication application. *Journal of Basic and Applied Scientific Research*, 2013, 3(11):365-372

How to cite this article:

Dianah ARSN, Hazmin SN, Umar R, Jaafar H, Kamarudin MKA, Dagang AN, Syafiqah HN. Spatial model of public non-ionizing radiation exposure on selected base station around Kuala nerus. *J. Fundam. Appl. Sci.*, 2018, 10(1S), 523-540.