

Impact of generation mix flexibility on the integration of variable renewable energies

M. M. Abdelzaher¹, H. M. Mahmoud¹, A. Y. Abdelaziz², S. F. Mekhamer², M. A. L. Badr²

¹ Egyptian Electricity Holding Company, Cairo, EGYPT

² Electrical Power & Machines Department, Faculty of Engineering, Ain Shams University, Cairo, EGYPT

*Corresponding Author: e-mail: almoatazabdelaziz@hotmail.com

Abstract

Worldwide, renewable energies are witnessing a huge expansion especially for power generation driven by different factors including the increased demand on fossil fuels and the depletion of its resources, the increase in its cost and the need to preserve the environment. Variable Renewable Energies (VRE) especially depending on wind and solar resources are intermittent by nature and this intermittency can have severe impacts on the operation of the power systems. Power systems are thus required to have a sufficient degree of flexibility to deal with this intermittency especially in the generation side. This paper introduces a hybrid Flexibility Enhanced Priority List-Mixed Integer Linear Programming (FEPL-MILP) method to solve the Unit Commitment (UC) problem and study the impact of the generation mix flexibility on the integration of renewable energies. Results show that, increasing the flexibility of the thermal energy mix used for power generation will have positive technical and economic impacts on the integration of renewable energies into the power system.

Keywords: Intermittency, Generation Mix, Flexibility, Unit Commitment

DOI: <http://dx.doi.org/10.4314/ijest.v10i3.1>

1. Introduction

Over the past years, the world has depended mainly on the conventional energy resources to meet its increasing electricity demand. Those energy resources however are expected to deplete over the next years, suffer from price fluctuations and release Green House Gas (GHG) emissions into the environment. Because of these challenges, the world has started to move from these conventional resources into renewable energy resources especially for meeting the electricity demand. However, VRE especially depending on wind and solar resources suffer from intermittency. Intermittency comprises two separate elements: non-controllable variability and partial unpredictability. Non-controllable variability implies likelihood that a renewable generation could be unavailable when needed. In terms of predictability, predicting the output of renewable generation is much more difficult than predicting the output of conventional generators or load. As an example for the lack of forecast accuracy, only very near-term wind predictions are highly accurate. In particular, the error for one to two hours ahead single plant forecasts can be about 5-7%. For day-ahead forecasts, the error increases up to 20% (Milligan et al., 2009).

For the supply/demand balance, this intermittency can result in two main problems that will challenge the stable and economic operation of the power system. The first problem occurs when high renewable generation is available during the system minimum load time so that the system operator may fail to reduce the output of the conventional generators (especially large base-load units) in operation to fully utilize the available renewable generation. As a result, the system operator will choose to curtail part of the renewable generation to keep the conventional units operating within its predefined technical and economical operation limits. The second problem occurs due to the high variability of the net load (initial system load minus the renewable generation) so that, the conventional generating units may not have the sufficient ramping capabilities for cycling their output to follow the net load changes and once again, the system operator may need to either curtail the renewable generation or to curtail part of the system load hence reducing the quality of power supply. Power systems facing these two problems are said to have a lack of flexibility.

Recent researches have investigated the importance of providing the required technical flexibility for integrating intermittent renewable energies. Adams et al. (2010) found that while flexibility has always been a necessary component for power systems given the uncertainty of demand and conventional generation outages, the growth in VRE increases the need for flexible resources. Troy et al. (2010) examined the serious impacts of increasing the penetration of fluctuating wind power on the operation of base load generation units and found a strong relation between system flexibility and renewable curtailment rates. Denholm et al. (2011) addressed the short-term flexibility demand due to VRE integration while Bruce et al. (2016) formulated an enhanced unit commitment model considering energy storage and flexible CO2 capture to study the impact of operational flexibility in integrating wind power. Price (2015) evaluated the potential benefits of stochastic unit commitment as another way of responding to uncertainty in intermittent resources' output for a practical case study of California's energy system. Lu et al. (2010) proposed a new framework for UC process incorporating generation flexibility requirements and environmental constraints into the existing unit commitment algorithm and found that, the generation flexibility is essential to address the uncertainty and variability associated with large amounts of intermittent renewable energy resources as well as with load.

The previous researches have revealed the fact that, most of the critical effects of VRE' intermittency occur during short term operational time horizon (minutes to days) while longer term effects are more smooth. Hence, the effects of intermittency and the possible role of generation flexibility in mitigating its effects are usually analyzed using UC models working in hours or sub hourly intervals. On the other hand, modern power systems are usually made up of large number of generation units that should be represented in details through these models. A common problem in the UC models is the increased complexity with the increase of the number of generation units for the system under study (curse of dimensionality) in addition to the need for strong computers to solve the problem which put a burden in the way of studying the effect of renewable intermittency for large power systems. This paper will thus focus on developing a quick and accurate method for solving the UC problem in the presence of renewable energy sources for large power systems. A new solution method; the hybrid FEPL-MILP method will be developed that will provide two main advantages. First, the method can provide fast and accurate results for power systems composed of large number of generating units with low computational requirements. Second, the method can study the technical and economic impacts of generation mix flexibility on integrating VRE (wind and solar PV).

2. Generation flexibility

Power system flexibility can be described as the ability of the power system to meet changes in the demand during an interval (Lannoye., 2010). In case of power systems including renewable energies, flexibility can be defined as the ability of the system to deploy its resources to respond to changes in net load, where net load is defined as the remaining system load not served by variable generation (Lannoye et al., 2012; Cochran et al., 2014).

The intermittency of renewable energies usually result in two main impacts; increasing the net load variability (frequency and magnitude of load ramps) as well as decreasing the net load below the levels accepted by system operators in terms of generators' technical and economic constraints. Such effects will magnify as the share of renewable energies increase in the system. In contrast to these load changes, the system generating units should have the sufficient flexibility to modify its output to keep tracking the net load without curtailing renewable generation and hence preserving the adequacy and quality of power supply. The flexibility of a generating unit usually depends on a number of parameters referred to as the unit's dynamic limits including, the Minimum Stable Generation (MSG) level, ramp rate and minimum up / down times. The interaction of these dynamic limits defines the amount and quality of flexibility provided by the power plant. The degree of flexibility provided varies from one generating unit to another hence, generating units can be generally classified into three main groups; low, medium and high flexibility units. The characteristics of each of group are given in Table 1.

Table 1. Flexibility characteristics of thermal generating units

Flexibility	MSG	Ramp Rate	Min Up/Down times	Examples
Low	High	Low	High	Nuclear P.P Coal P.P
Medium	Medium	Medium	Medium	Fossil fired steam P.P
High	Low	High	Low	Gas Turbines Combustion Turbines

It is important to mention that, energy storage units can also provide flexibility by absorbing most of the net load variability through storing surplus renewable energies or discharging the stored energy in times of low renewable generation however, this paper will only focus on the flexibility provided by thermal generating units. Modern power systems are usually made up of large numbers of generating units of different sizes, types and different flexibility characteristics with the objective of meeting the system load with the lowest cost and maximum reliability while preserving the environmental considerations. In this way, the combination of these generating units defines the degree of flexibility in the power system as well as the cost and quality of

providing this flexibility. Hence two power systems of the same generation capacities but of different mix of generation capacities will have different levels of flexibility as well as different costs to deliver this flexibility. Accordingly, the two systems will also vary in the level of renewable energies that can be accommodated.

3. Unit Commitment Problem

The demand for electricity usually follows a typical diurnal, weekly and seasonal patterns driven by many factors including the type of customers (industrial, commercial, residential ...etc), the customer behavior, change in weather and others. In contrast, the electricity supply must cope with this varying demand to keep the balance and stability of the power system. Hence, it is important for the system operator to schedule or commit the required generation capacities ahead to meet the forecasted demand. In this regard, the UC problem can be defined as the problem of scheduling the proper mix of generators to meet the system demand with the required level of reliability and least cost while accounting for the different system and generator level constraints.

System level constraints are usually applied to ensure that the committed capacities will be sufficient to meet the demand with acceptable level of reliability (Ex. spinning reserve constraint) during the optimization horizon. On the other hand, the generator level constraints are applied to ensure that, the operation of the generating unit will consider the different dynamic limits recommended for healthy and economic operation of the generating unit. Examples of these limits are the unit output range specified by the minimum and maximum stable generation levels, the max ramping up and down constraints and minimum up and down times.

Due to the large number of variables and constraints imposed in the solution, UC problem usually suffers from computational problems especially in the case of large power systems composed of hundreds of generating units. Different techniques have been applied to solve the UC problem including for example, Lagrangian relaxation (Svoboda et al., 1997; Qiaozhu et al., 2002; Guan et al., 2003), Dynamic Programming (DP) (Snyder et al., 1987), Priority List (PL) (Senjyu et al., 2003; Xinda et al., 2015; Delaurue et al., 2013), Mixed Integer Linear Programming (MILP) algorithm (Miguel et al., 2006; Ostrowski et al., 2012). In addition, modern Artificial Intelligence (AI) techniques such as, Simulated Annealing (SA), Fuzzy Logic (FL), Genetic Algorithms (GA), Particle Swarm Optimization (PSO), Tabu Search (TS) and Hopfield Neural Network (HNN) and Augmented Hopfield Network (AHN) methods (Kamh et al., 2009).

Each of the previous methods can provide some advantages while also suffering from certain disadvantages. For example, the characteristics of the MILP and PL methods, we can be concluded as follows:

MILP: This operational research method consists of an objective function (usually a cost minimization) as a function of variables (generator's on/off states, generator's output power, etc.) and several constraints on these variables. Some of the variables can be constrained to be binary (either 0 or 1) while other variables can be integer. In addition, The UC problem is highly suitable to be written as an MIP. It makes the problem easily and clearly accessible for adaptations. However, for large-scale systems, this method might become more difficult to use, as its computation time typically increases exponentially with the problem size. Therefore, approximation and simplification of MILP for the UC problem are necessary. In recent years, MILP has become very popular for solving the UC problem due to advances in MILP solvers (Xinda et al., 2015; Delaurue et al., 2013; Padhy et al., 2004).

PL: This is one of the simplest ways of tackling the UC problem. The method starts by ranking the generating units according to its production cost and then switches the generating units necessary to meet the demand according to this ranking. The PL methods are simple, fast and can provide feasible solutions however; it can not guarantee optimal solutions (Xinda et al., 2015; Delarue et al., 2006). In addition, this method will fail to meet some of the problem constraints like minimum up/down time constraints. Hybrid methods are based on the combination of one or more of the previously mentioned techniques in order to obtain a new technique with better performance than the individual ones (Delarue et al., 2006; Padhy et al., 2004). For example, hybrid FL, TS, PSO, and Sequential Quadratic Programming (SQP) is used to solve the fuzzy-modeled UC problem (Victoire et al., 2006). A hybrid of priority list and Lagrangian-based AHN is used to solve ramp-rate constrained UC problem (Dieu et al., 2008). A hybrid of DP and HNN is used to solve short term UC problem (Kumar et al., 2007). Other hybrid methods were reported in like TS/SA, GA/TS, and GA/SA/TS (Mantawy, 1997). Xinda et al. (2015) introduced a two steps hybrid MILP-PL method for improving the computational speed of UC programs while preserving optimality.

This paper will introduce an enhanced hybrid PL-MILP method to solve the UC problem efficiently while reducing the solution and the computational requirements especially for large power systems. The developed method will also focus on the concept of generation flexibility that has recently gained a lot of interest especially with the rapid growth in renewable energies.

4. Methodology

The proposed methodology consists of two parts. In the first part, the FEPL method will be applied to prepare a list of all the possible states for the system generators based on the ranking of their full load average production cost defined by equation (1):

$$C_i = \frac{a_i + b_i * P_{\max i} + c_i * P_{\max i}^2}{P_{\max i}} \tag{1}$$

where a, b and c are the cost coefficients for each generating unit. The list of states is prepared such that, the units with the lowest production cost are committed first then the more expensive ones and so on until committing the last unit in the system which will be the most expensive unit to operate. Table 2 shows a typical example of priority list for 10 units system.

Table 2. Proposed generator states for classical P.L method

Unit Number	1	2	3	4	5	6	7	8	9	10
Average Production Cost (\$/MWh)	8	11.3	18.4	21	23	26.5	28	35	37.7	40

State / Unit Number	1	2	3	4	5	6	7	8	9	10
1	1	0	0	0	0	0	0	0	0	0
2	1	1	0	0	0	0	0	0	0	0
3	1	1	1	0	0	0	0	0	0	0
4	1	1	1	1	0	0	0	0	0	0
5	1	1	1	1	1	0	0	0	0	0
6	1	1	1	1	1	1	0	0	0	0
7	1	1	1	1	1	1	1	0	0	0
8	1	1	1	1	1	1	1	1	0	0
9	1	1	1	1	1	1	1	1	1	0
10	1	1	1	1	1	1	1	1	1	1

1: Generator turned ON
 0: Generator turned OFF

It is important to note that, the number of states generated will be limited to the number of units (N) instead of (2N) states that can reduce the required simulation time as well as the required computational capacities especially for large power systems. However, this behavior can present a drawback of the method since a certain generating unit may not be committed due to its high production cost although having the required technical capabilities required to keep the balance of the system. As was discussed in the previous section, although the high flexibility generation units are suitable to deal with the variability introduced by RES, it also suffers from high production cost compared to the lower flexibility units. As a result, the traditional PL method will postpone the commitment of such units into the end of the proposed states i.e. it will be only operated during on-peak periods. Accordingly, the classical PL algorithm will fail to commit these units during the off-peak periods even required to preserve the supply / demand balance and enhance the economic utilization of RES by minimizing its curtailment while protecting the system from its variability.

To deal with this problem, this paper proposes a new FEPL method which enables the commitment of flexible units when needed regardless of their commitment priority while still maximizing the utilization of the least cost generation units. The algorithm starts by classifying the system units according to their flexibility degree into three groups; the first group contains low flexibility base-load units while the second group contains the medium flexibility units and the third contains the high flexibility units. For each group, a priority list will be separately generated according to the order of the unit’s average production cost in the group. In each time step, the model will start by examining the possible states in the first group enjoying the low production cost and if needed, the model can pick up additional units from the second group with higher flexibility or from the third group with the highest flexibility. In this way, the model will still preserve the basic advantages of the priority list method; high speed, low computational requirements and capability to find economically and technically feasible solution while accounting for the power system’s flexibility needs and providing higher capability of operating the flexible generation units when needed.

It is important to clarify that, the number of possible generator states resulting from this modified algorithm will be (m (n+1) (s+1)) compared to (m+n+s) in the classical algorithm where m is the number of generators in the first group, n is the number of generators in the second group and s are the number of generators in the third group. As an example, consider the 10 units power system used to generate the states in Table 2 and assuming that units 1 to 3 are low flexible units, units 4 to 6 are medium flexibility units while units 7 to 10 are highly flexible units (i.e. m=3, n=3 and s=4), then the number of states proposed by the new algorithm will be 60 states instead of 10 states in the classical method. Table 3 shows the proposed generator states where group A contains the low flexibility units; group B contains the medium flexibility units while group C contains the high flexibility units.

Table 3.Flexibility enhanced priority list for 10 units'system

Unit Number	1	2	3	4	5	6	7	8	9	10
Average Production Cost (\$/MWh)	8	11	18	21	23	25	29	35	38	40
Group	A			B			C			
State / Unit Number	1	2	3	4	5	6	7	8	9	10
1	1	0	0	0	0	0	0	0	0	0
2	1	0	0	0	0	0	1	0	0	0
3	1	0	0	0	0	0	1	1	0	0
4	1	0	0	0	0	0	1	1	1	0
5	1	0	0	0	0	0	1	1	1	1
6	1	0	0	1	0	0	0	0	0	0
7	1	0	0	1	0	0	1	0	0	0
8	1	0	0	1	0	0	1	1	0	0
9	1	0	0	1	0	0	1	1	1	0
10	1	0	0	1	0	0	1	1	1	1
11	1	0	0	1	1	0	0	0	0	0
12	1	0	0	1	1	0	1	0	0	0
13	1	0	0	1	1	0	1	1	0	0
14	1	0	0	1	1	0	1	1	1	0
15	1	0	0	1	1	0	1	1	1	1
16	1	0	0	1	1	1	0	0	0	0
17	1	0	0	1	1	1	1	0	0	0
18	1	0	0	1	1	1	1	1	0	0
19	1	0	0	1	1	1	1	1	1	0
20	1	0	0	1	1	1	1	1	1	1
21	1	1	0	0	0	0	0	0	0	0
22	1	1	0	0	0	0	1	0	0	0
23	1	1	0	0	0	0	1	1	0	0
24	1	1	0	0	0	0	1	1	1	0
25	1	1	0	0	0	0	1	1	1	1
26	1	1	0	1	0	0	0	0	0	0
27	1	1	0	1	0	0	1	0	0	0
28	1	1	0	1	0	0	1	1	0	0
29	1	1	0	1	0	0	1	1	1	0
30	1	1	0	1	0	0	1	1	1	1
31	1	1	0	1	1	0	0	0	0	0
32	1	1	0	1	1	0	1	0	0	0
33	1	1	0	1	1	0	1	1	0	0
34	1	1	0	1	1	0	1	1	1	0
35	1	1	0	1	1	0	1	1	1	1
36	1	1	0	1	1	1	0	0	0	0
37	1	1	0	1	1	1	1	0	0	0
38	1	1	0	1	1	1	1	1	0	0
39	1	1	0	1	1	1	1	1	1	0
40	1	1	0	1	1	1	1	1	1	1
41	1	1	1	0	0	0	0	0	0	0
42	1	1	1	0	0	0	1	0	0	0
43	1	1	1	0	0	0	1	1	0	0
44	1	1	1	0	0	0	1	1	1	0
45	1	1	1	0	0	0	1	1	1	1
46	1	1	1	1	0	0	0	0	0	0
47	1	1	1	1	0	0	1	0	0	0
48	1	1	1	1	0	0	1	1	0	0
49	1	1	1	1	0	0	1	1	1	0
50	1	1	1	1	0	0	1	1	1	1
51	1	1	1	1	1	0	0	0	0	0
52	1	1	1	1	1	0	1	0	0	0
53	1	1	1	1	1	0	1	1	0	0
54	1	1	1	1	1	0	1	1	1	0
55	1	1	1	1	1	0	1	1	1	1
56	1	1	1	1	1	1	0	0	0	0
57	1	1	1	1	1	1	1	0	0	0
58	1	1	1	1	1	1	1	1	0	0
59	1	1	1	1	1	1	1	1	1	0
60	1	1	1	1	1	1	1	1	1	1

1: Generator turned ON

0: Generator turned OFF

In the second part of the methodology, the proposed generator commitment states resulting from the first step will be applied to the second part that is based on MILP optimization. The optimization is based on the minimization of the objective function given by equation (2) including into two main terms; the first part will include the production cost of generating units (sum of unit's production and startup costs) while the second term will include the penalty cost related to insufficient flexibility (cost of curtailed load and renewable generation) (Zhang et al., 2015). A more detailed form of the objective function is given by equation (3).

$$Min.TSC = \sum_{h=1}^H [\sum_{i=1}^N C_{h,i}^{flex} + C_h^{inflex}] \tag{2}$$

$$Min.TSC = \sum_{h=1}^H [\sum_{i=1}^N ([C_i] * P_{h,i}) + (SUC_i(S_{h,i}(1 - S_{h-1,i}))) + V_{CRES_h} + V_{LOL_h}] \tag{3}$$

The optimization of the objective function will be subjected to the following system level and generator level constraints as follow.

A- *System Level Constraints:*

1- *Demand Balance*

$$\sum_{i=1}^N ((P_i * S_{h,i} + \sum_{j=1}^R RES_{h,j}) - CRES_{h,j}) \geq (L_h - LOL_h) \tag{4}$$

2- *Spinning reserve*

Spinning reserve refers to the extra generation capacity available from the synchronized (spinning) generation units after serving the system demand. This extra capacity is usually used to keep the system stable in case of sudden generator trip or unplanned increase in the system demand.

$$\sum_{i=1}^N ((P_{max_i}) * S_{h,i}) \geq (L_h + SR) \tag{5}$$

$$SR = \text{Max} (P_{max_i} * S_{h,i}) \tag{6}$$

B- *Generator Level Constraints*

1- *Generator Output limits*

Each generator can provide output power in the range specified by its minimum and maximum power levels.

$$P_{mini} \leq P_{h,i} \leq P_{maxi} \tag{7}$$

2- *Generator Ramping limits*

Ramp rates define the capability of the generating unit to change its output (either up or down) during two successive time steps. This constraint is thus applied to ensure that, the change of the unit’s output power during two successive time steps will be lower than or equal to the maximum ramp rate specified for that unit.

$$|(P_{h,i} - P_{h-1,i})| \leq RUP_1 \tag{8}$$

$$|(P_{h-1,i} - P_{h,i})| \leq RDN_1 \tag{9}$$

3- *Generator UP/Down time limits*

Once the generating unit is turned on, it has to keep running for a certain number of successive time steps referred to as the minimum up time. Similarly, once the unit is turned off, it has to stay off for a certain number of successive time steps referred to as the minimum down time before it can be turned on again. These constraints are applied to protect the unit from the fatigue and increased wear that can result from the successive turning the unit on and off which can shorten the unit’s lifetime and introduce severe technical and economic losses to its operation. The following two equations are used to keep the up and down times for each unit within the recommended limits.

$$T_{oni} \geq T_{minUPi} \tag{10}$$

$$T_{offi} \geq T_{minDNi} \tag{11}$$

Based on the previous methodology, a computer model was built using MATLAB software to solve the UC problem with high share of renewable energies.

5. Case study

Using the developed MATLAB UC model, this section will introduce a case study to test the impact of generation flexibility on the integration of renewable energies in the power systems. The study considers the IEEE-RTS single area test system with a total installed capacity of 3405MW. This capacity can be broken down into 3105 MW of fossil-fired units (26 thermal units with capacities ranging from 12 to 400 MW) in addition to 300 MW of hydro unit. It should be noted that, the system has voltage corrective devices at bus14 (synchronous condenser) and at bus6 (reactor). Table 4 shows the bus location for each generating unit

in the system. On the other hand, the system's load varies over the different time-periods (hours, days and seasons) with a yearly peak load of 2850 MW. Such system can work as a good representation for ordinary power system that is composed of different generating units with different flexibility characteristics for each. Fig (1) shows the schematic diagram for the IEEE_RTS system used in the study. A more description about the IEEE_RTS system can be found in (Grigg et al., 1999; Wang et al., 1993).

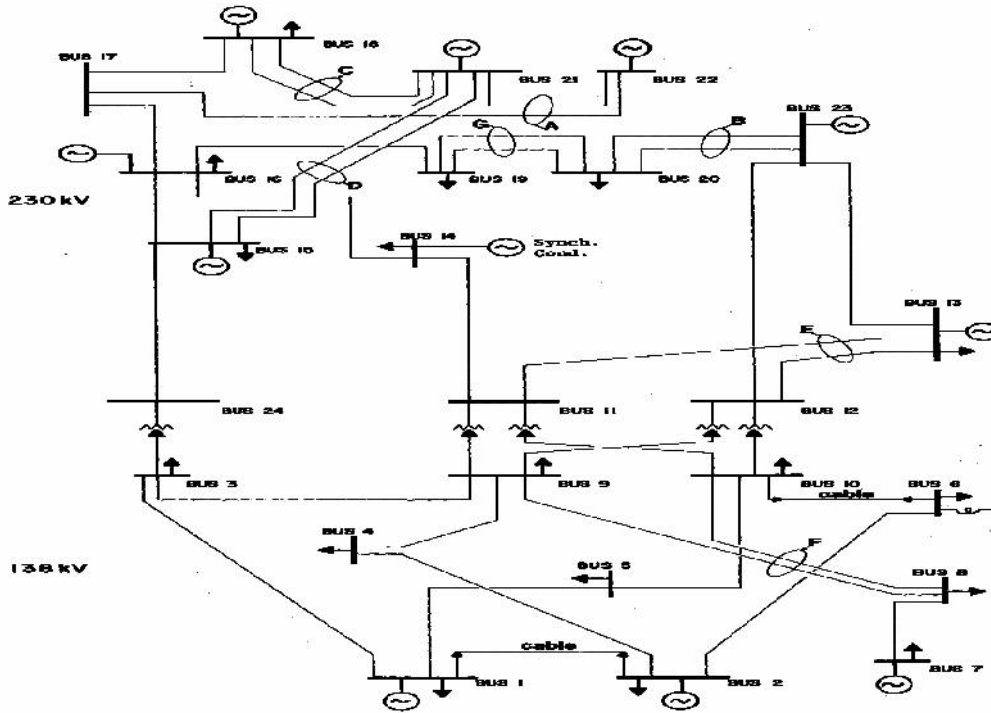

Figure 1. IEEE_RTS system schematic diagram

Table 4. Bus locations for thermal generation units

Bus	Unit 1 MW	Unit 2 MW	Unit 3 MW	Unit 4 MW	Unit 5 MW	Unit 6 MW
1	20	20	76	76		
2	20	20	76	76		
7	100	100	100			
13	197	197	197			
15	12	12	12	12	12	155
16	155					
18	400					
21	400					
22	50	50	50	50	50	50
23	155	155	350			

As the paper focuses on the flexibility provided by thermal generating units, the UC model will only consider the thermal generating units that can be classified by their flexibility as in Table 5. From this table, it is clear that, most of the system load will be met by low flexibility base load units accounting for 66.8% of the total thermal capacity while medium and high flexibility units account for 30.6% and 2.6% respectively.

Table 5. Classification of IEEE-26 system thermal units by flexibility

Type	Capacity (MW)	Share (%)	Flexibility
Nuclear	800	25.8	Low
Coal fired steam	1274	41	Low
Oil fired steam	951	30.6	Medium
Combustion Turbines	80	2.6	High

To test the new UC methodology as well as the effect of generation mix flexibility on the integration of renewable energies, the mix of thermal capacities in the IEEE26 system was modified into three energy mix scenarios with different shares of low, medium and high flexibility generation units while having almost the same total installed capacity. Accordingly, the three energy mixes (referred to as LF, MF and HF) which are shown in Table 6 will represent the change in the power system capability of providing generation flexibility. For each of the three scenarios, the VRE are assumed to meet 20% of the annual electricity demand.

Table 6. Data for case studies

Energy Mix	Low Flexibility Generation (%)	Medium Flexibility Generation (%)	High Flexibility Generation (%)
LF	51	44	5
MF	51	38	10
HF	38	42	20

Based on the discussion in section (2), two representative days will be simulated corresponding to the day with minimum annual net load and the day with maximum annual net load variability. Those two days represent the major flexibility challenges for the energy mix. In the first day, the system should have the sufficient ramping capability to meet the net load rapid variations caused by the variable renewable generation while in the second day; the system has to reduce its generation capacity to meet the minimum grid net load. Renewable energies are assumed to have the highest dispatch priority and almost zero marginal costs. The penalty cost for curtailed load was assumed to be 2000 \$/MW while no penalty cost was assumed for renewable curtailment.

To test the impact of different renewable expansion scenarios, three groups of case studies were prepared (namely groups A, B and C). In group (A), the renewable target will be completely met by wind power. In group (B), the target will be completely met by solar PV while in group (C), the target will be equally met by both wind and solar PV with each meeting 10% of the total annual energy demand. For wind power, a random hourly generation time series was generated using MATLAB and scaled to meet the target while for solar power, an actual hourly generation time series for solar panels located in Cairo was used. Fig (2) shows the initial system load curve along with the resulting net load curve for each of the three groups. From this figure, the impact of the different renewable expansion scenario on the system net load will be as follows:

- 1- For group (A) – Fig (2-a), and while not altering the load pattern, the introduction of high wind capacities (with total capacity of about 685 MW) into the system will result in increasing the variability of the net load (high load ramps) as well as reducing the minimum net load below the initial minimum load value in Day2.
- 2- For group (B) – Fig (2-b), the introduction of high solar PV capacities (with total capacity of about 1345 MW) into the system will result in lower variability of the net load however it will introduce higher reduction in the system minimum net load as well as altering the load pattern. This reduction will take place during the middle of the day when the solar intensity is high while the system load is still growing driven by the increasing activity of the consumers.
- 3- For group (C) – Fig (2-c), the introduction of a balanced mix of wind and solar PV capacities (with total capacities of 340 MW and 675 MW respectively) will smooth out a considerable part of net load variability result and reduce the altering of the net load pattern. Also, the resulting minimum net load level will be higher in this case than that in group (B) hence putting lower operational constraints on the base load units.

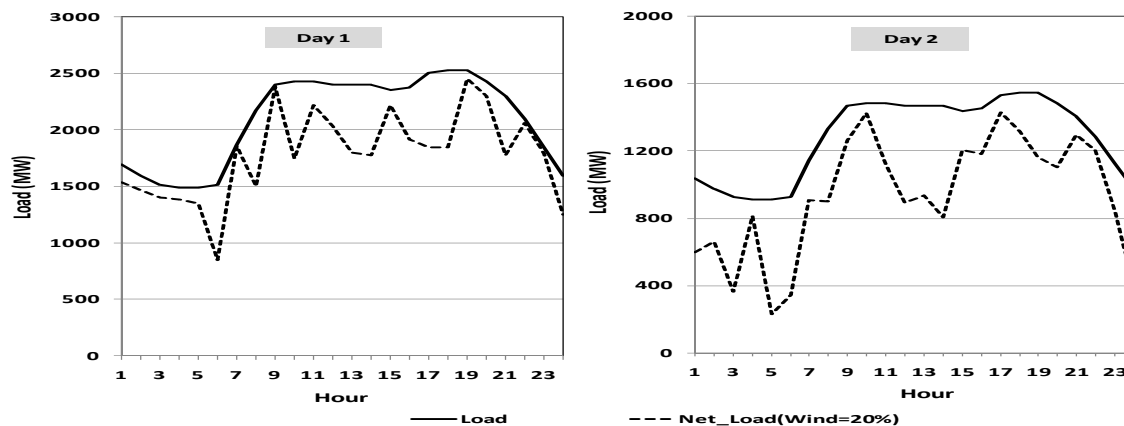

(a)

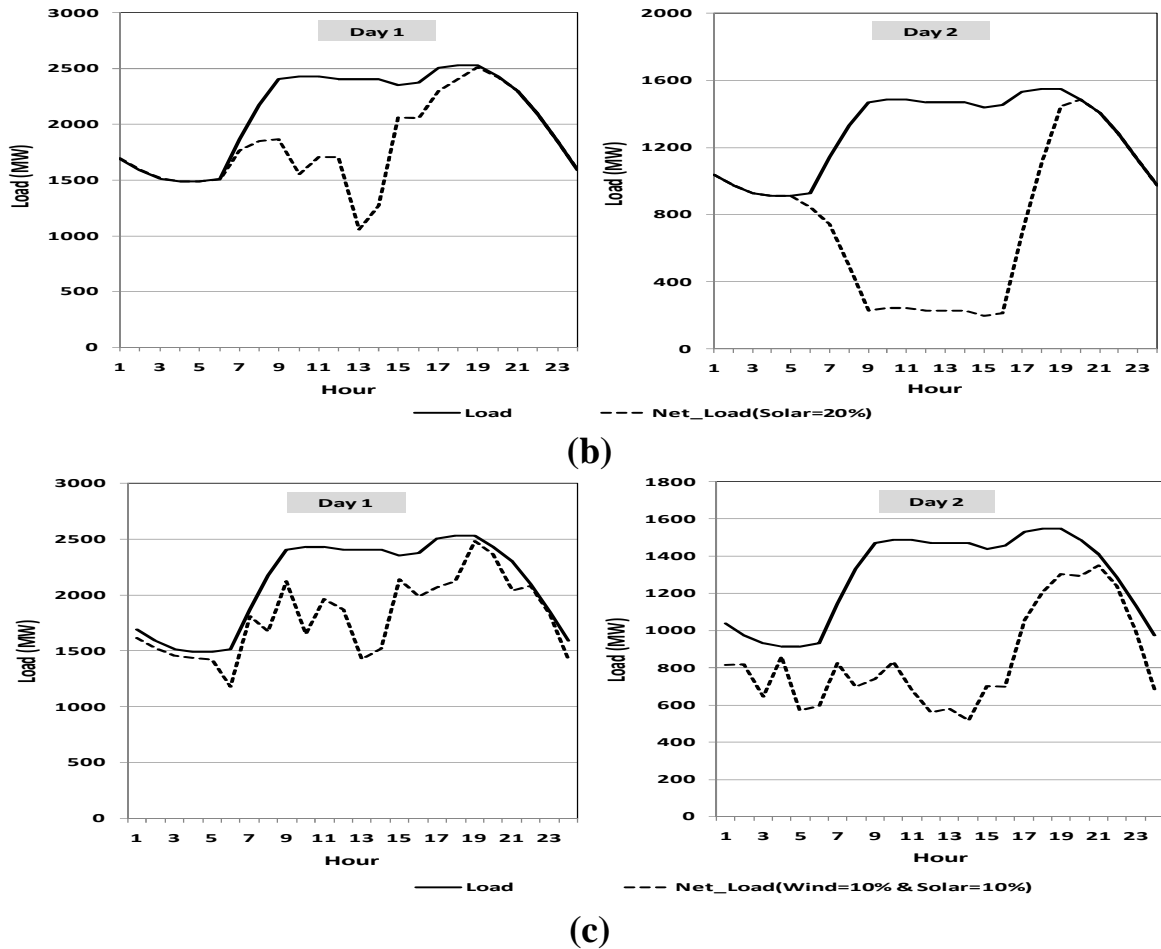

Figure 2. IEEE26 system load and net load for the different renewable expansion scenarios

6. Simulation Results

Each of the three energy mixes were first simulated to ensure its capability to meet the system load at least possible cost and without any curtailment. Then, for each of these mixes, the three net load curves related to the renewable expansion scenarios were simulated using the developed UC model. For each case, the output of the model represents the least cost commitment of the thermal generating units to meet the hourly net load in the two representative days. In addition, a number of indicators will be used to assess the technical and economic impacts of generation mix flexibility including the curtailed system demand, curtailed renewable generation, number of generator starts and the total system cost. The results obtained were as follows:

Group A: (Renewable target is met by wind power)

Under this group of scenarios, the wind power is assumed to meet 20 % of the system total annual energy demand. The different technical and economic indicators for this group of cases are shown in Table 7 for the three energy mixes.

Table 7. Technical and economic indicators for group (A) cases

Scenario / Indicator	Curtailed Load (MW)	Curtailed Renewable Generation(MW)	No. of Starts	Total System Cost (M\$)
LF	791	790	84	2.10
MF	471	682	115	1.46
HF	251	641	163	1.12

From the previous results, it's clear that, increasing the flexibility of the thermal energy mix has resulted in the reduction of the curtailed load as well as curtailed renewable generation which has been reflected in the form of reduction of the total system cost from 2.1 million \$ in the LF mix down to 1.1 million \$ for the HF mix (by almost 50%). It can also be seen that, the number of generator starts has increased significantly by about 100% which is another sign of increased system flexibility. Fig (3) shows the

breakdown of the number of generator starts per the type of generation for each case in group (A) while Fig (4) shows the hourly generation output per type of generation resulting from the UC model for the HF mix in each of the two representative days.

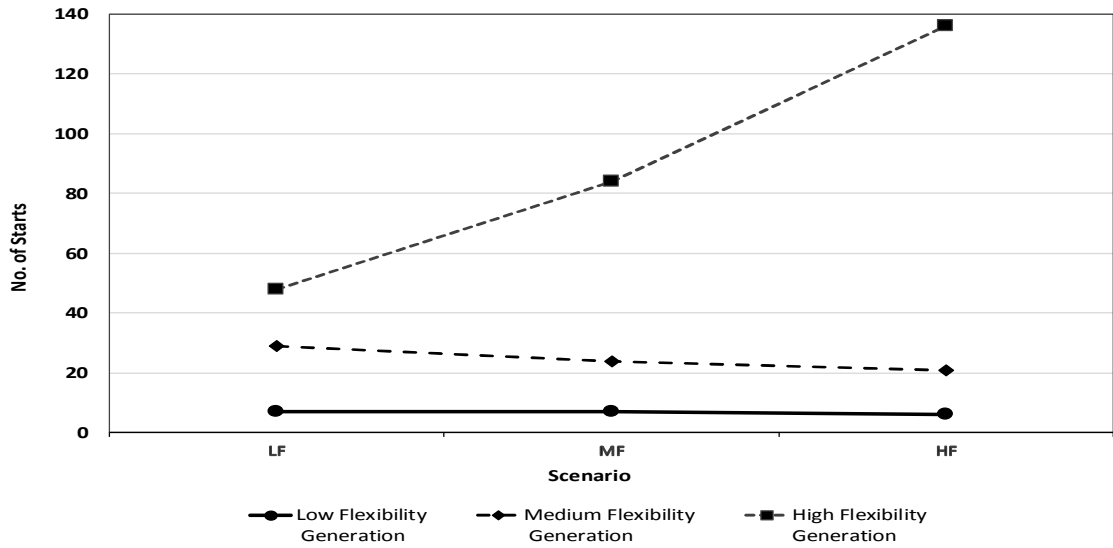

Figure 3. Number of starts per type of generation - Group (A)

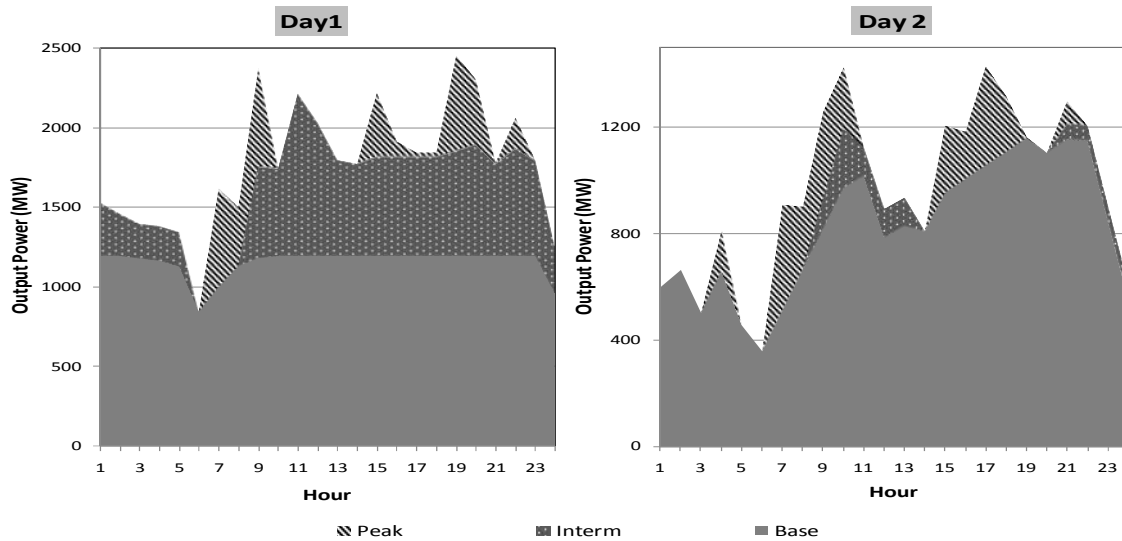

Figure 4. Hourly thermal generation output per type - Group (A)

From the previous figures, it is clear that, for the different generation mix scenarios, the number of starts for low flexibility base load generators is constant as this type of power plants is designed to generate electricity with the lowest cost hence the model will always select to operate these units as the first choice to meet the system load followed by the intermediate and peak units with higher generation cost. On the other hand, with increasing the share of high flexibility units, the system will reduce the number of starts for the medium flexibility units which have higher start up cost and will instead start up the high flexibility units which have lower start up cost but higher generation cost. This effect can be seen in Fig (4) where most of the large net load ramps will be met by the high flexibility peak units while medium flexibility intermediate units will show less variability in its output. This increased degree of flexibility will allow the model to absorb as much as possible of the available wind generation while also reducing the curtailed system load.

Group B: (Renewable target is met by Solar PV power)

Under this group of scenarios, the solar power is assumed to meet 20 % of the system total annual energy demand. The different technical and economic indicators for this group of cases are shown in Table 8 for the three flexibility energy mixes.

Table 8. Technical and economic indicators for group (B) cases

Scenario / Indicator	Curtailed Load (MW)	Curtailed Renewable Generation(MW)	No. of Starts	Total System Cost (M\$)
LF	420	269	44	1.33
MF	284	269	54	1.07
HF	0	202	85	0.62

In this case, a similar positive effect of generation flexibility will take place however; it's important to notice that, the higher predictability and lower variability of PV generation compared to wind generation will result in lower curtailed load reaching to zero in the high flexibility mix and lower curtailed renewable generation (almost one third of the curtailed wind generation for similar cases in group (A)) hence calling for lower system cost. Also, this lower variability will reduce the number of generator starts by 50% compared to the similar case in group (A) which will also reduce the system start up costs and accordingly the system total cost. Fig (5) shows the breakdown of the number of generator starts per the type of generation for each case in group (B) while Fig (6) shows the hourly generation output per type of generation resulting from the UC model for the high flexibility mix in each of the two representative days. Once again, it's clear that, most of the net load variability will be met by the high flexibility units followed by the medium flexibility units. for the low flexibility base load units, it's important to mention that, although not capable of providing the required high ramping capabilities however it can provide another aspect of flexibility through reducing its output to the MSG level during the high solar generation period as in the representative day 2.

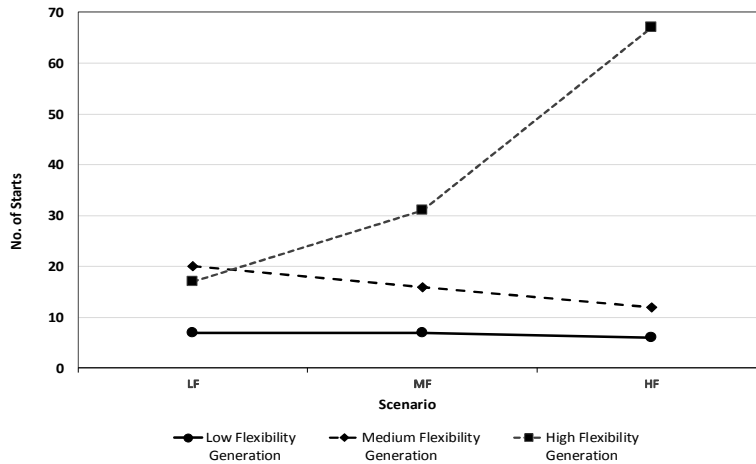

Figure 5. Number of starts per type of generation - Group (B)

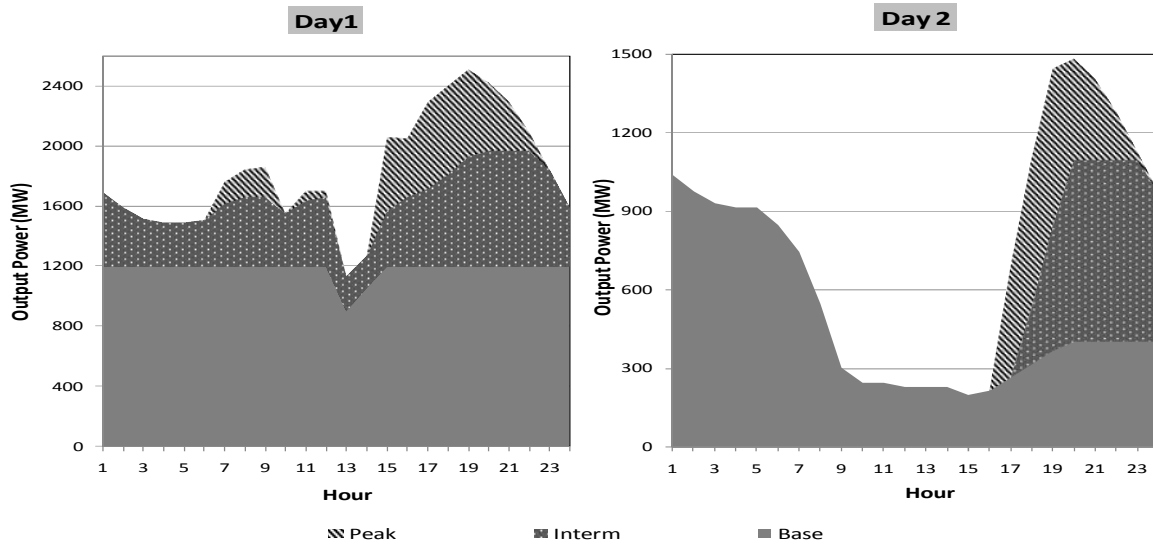

Figure 6. Hourly thermal generation output per type - Group (B)

Group C: (Renewable target is met by equal shares of Wind and Solar PV power)

Under this group of scenarios, each of wind and solar power is assumed to meet 10 % of the system total annual energy demand. The different technical and economic indicators for this group of cases are shown in Table 9 for the three flexibility energy mixes.

Table 9. Technical and economic indicators for group (C) cases

Scenario / Indicator	Curtailed Load (MW)	Curtailed Renewable Generation(MW)	No. of Starts	Total System Cost (M\$)
LF	598	0	64	1.69
MF	193	0	74	0.89
HF	0	0	117	0.60

As was seen in Fig (2-c), the introduction of a balanced mix of wind and solar PV capacities will result in a smoothing effect so that, the resulting impacts from wind and solar power intermittency will be much lower than that introduced by any of these sources individually. As a result, the net load to be met by thermal units will be much smoother than the net load resulting from group (A) or group (B). This has been reflected to the operation of the generating units and also to the ability of the system to absorb the renewable generation while avoiding the resulting negative effects. From the above table, it's clear that, this smoothing effect will allow the system to fully absorb the available renewable generation from solar and wind power without curtailments either in the system load or from renewable generation especially for the HF mix. This will result in the lowest system cost among all the cases studied as well as the highest system reliability since no load was curtailed. For the number of generator starts and while higher than that in group (B) due to the presence of wind power variability however, it will be far lower than that in group (A) where the entire renewable target is met by wind power. This can be considered once again a result of the smoothing effect of wind and solar power. Fig (7) shows the breakdown of the number of generator starts per the type of generation for each case in group (C) while Fig (8) shows the hourly generation output per type of generation resulting from the UC model for the HF mix in each of the two representative days.

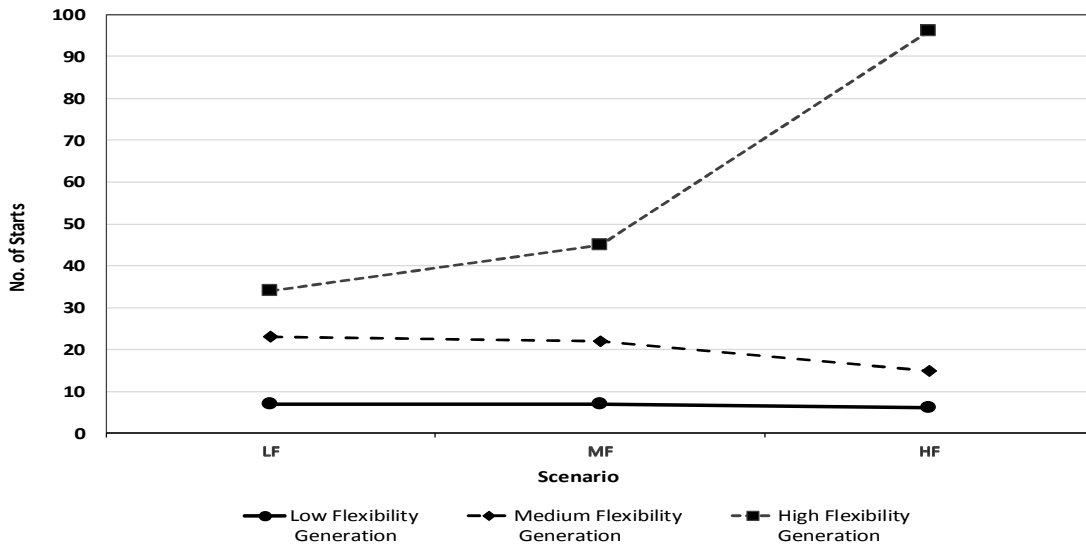

Figure 7. Number of starts per type of generation for -Group (C)

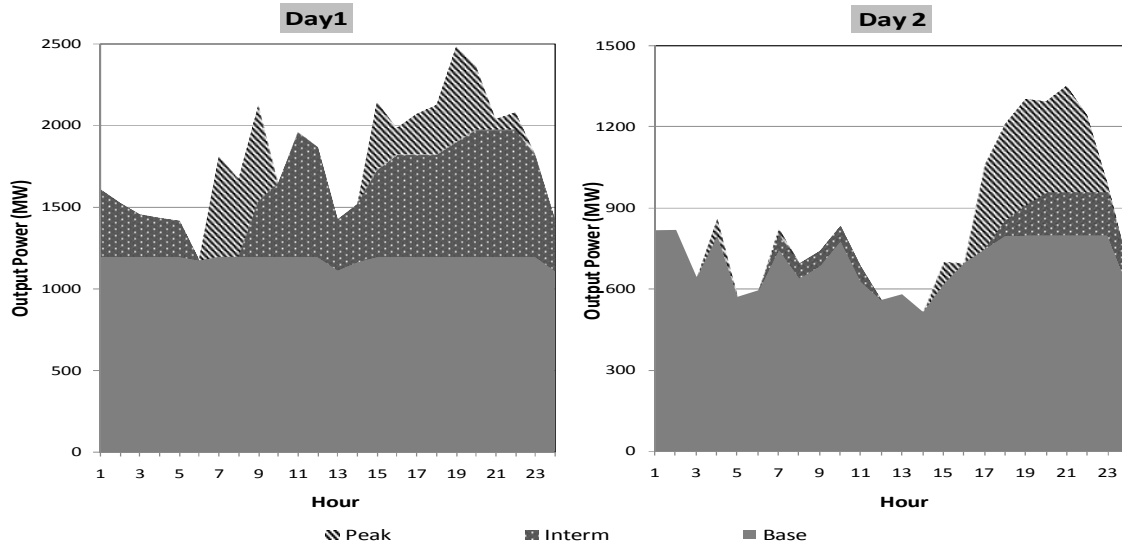

Figure 8. Hourly thermal generation output per type - Group (C)

It is worth to mention that, compared to the previous cases, the output of base load generation units with least generation cost will have smoother operation with almost zero output variation as can be seen in Fig (8) for day 1 while will be still better for day 2.

As can be seen, the previous results highlight the value of generation mix flexibility in integrating VRE while mitigating the impacts of these resources on the safe operation of the power system. In addition, generation flexibility has resulted in decreasing the amount curtailed renewable generation and replacing considerable part of the thermal generation and thus achieving higher savings in fossil fuels consumed as well as the GHG emissions released from thermal generation units.

Recent researches conducted to assess the importance of generation flexibility have reached to concluding results similar to the current obtained results. As an example to these researches, Bruce et al. (2016) used a UC model to test the effect of generation flexibility from thermal generation units and energy storage units on the integration of wind power in the United Kingdom power system. Lu et al. (2010) developed a framework for the UC process considering the uncertainty and variability of intermittent resources and power system load, and adding generation flexibility constraints in the optimization. The results showed the importance of generation flexibility in avoiding the occurrences of energy surplus and deficit situations caused by large RES' forecast errors and also to achieve considerable environmental benefits. Delarue et al. (2012) developed an enhanced priority list UC model to study the integration of large share of RES into the power system with special focus on covering the minimum net load periods while EniR et al. (2017) used a Security Constrained Unit Commitment (SCUC) model to reveal the thermal power plants flexibility requirements for integrating solar energy into the Nigerian Power Sector by analyzing the needs for system operational flexibility. The developed model was used to schedule the thermal generating units with minimum cost subject to dynamic constraints relevant to the flexibility requirement.

The contribution of this research against the previous ones is the development of the new UC solution method; the hybrid Flexibility Enhanced Priority List-Mixed Integer Linear Programming (FEPL-MILP) method. Compared to the solution methods utilized in the previous papers, this method enables the solution of UC problem for large power systems with special focus on assessing the generation flexibility required to integrate VRE at reasonable simulation time and without consuming much of the computational capabilities.

7. Sensitivity Analysis

In this section, a sensitivity analysis will be performed to study how the model solution is affected by small perturbations in input variables and parameters. Based on the discussion in section (2) about the technical parameters defining the flexibility of generation units, two sensitivity analysis will study the effect of changing the level of generators MSG and ramp rates and evaluate the corresponding effects on the obtained results. From the previous section, it appears that scenario (1) in group (A) represents the worst case for the renewable energies expansion in this study and hence it will be used as a reference case for this sensitivity analysis. For the first sensitivity analysis, the MSG level for all the generation units will be reduced by 10%, 20% and 30% respectively from the levels in the reference case. For each of these cases, the corresponding simulation results are shown in Table 10.

Table 10.Sensitivity analysis of the results to generators’ MSG level

Scenario / Indicator	Curtailed Load (MW)	Curtailed Renewable Generation(MW)	No. of Starts	Total System Cost (M\$)
Reference Scenario	791	858	92	2.09
Case 1	821	768	95	2.14
Case 2	835	668	95	2.17
Case 3	855	618	103	2.20

The previous results represent a paradox so that, while the curtailed renewable generation will decrease as the MSG level goes down, the curtailed system load will increase. Hourly commitment results can explain this behavior by that, during the hours with low demand and high RES generation, the output of some thermal generation units will go down to its MSG levels. However, in successive hours when the RES generation suddenly goes down and demand increases (negative correlation), the model will try to increase the generation from the previously committed units however, the resulting increase in the output power will be limited by the generators' low MSG level and the ramp rates which may not be sufficient to meet the system demand in these hours. To recover this problem, the system will try to commit additional generation units which lead to the increase in the number of generators starts. In addition, the system total cost will increase as a result of the penalties paid for the increasing curtailments in system demand. This behavior especially occurs for low flexibility generation units with low ramp rates and highlights the impact of the correlation between system demand and RES generation.

In the second sensitivity analysis, the up and down ramp rates for all the generation units will be increased by 10%, 20% and 30% respectively from the levels in the reference case. For each of these cases, the corresponding simulation results are shown in Table 11. This time, the increase in the ramp rates has increased the generators' capabilities to recover any sudden change in the system demand or RES generation hence, resulting in lower curtailments either in the system demand or RES generation. Due to the higher ramping capabilities available in this case, the number of generators committed (especially, the HF generators) will go down and accordingly the number of generators starts will go down. The resulting reduction in the demand and RES curtailments will decrease the system' total cost below the reference case value hence achieving higher economic and environmental benefits to the system.

Table 11. Sensitivity analysis of the results to generators’ ramp rate

Scenario / Indicator	Curtailed Load (MW)	Curtailed Renewable Generation(MW)	No. of Starts	Total System Cost (M\$)
Reference Scenario	791	858	92	2.09
Case 1	743	660	87	1.99
Case 2	687	580	84	1.87
Case 3	664	512	84	1.82

8. Conclusion

In this paper, a new hybrid PL-MILP method for solving the unit commitment problem has been proposed to test the effect of increasing the generation mix flexibility (mainly from thermal generating unit) on mitigating the impacts of VRE into the power systems. Different scenarios for the mix of renewable energies applied and also for the degree of flexibility available in the thermal energy mix have been tested. The impacts of renewable energies variability were evaluated using a number of technical and economic indicators such as the amount of curtailed load, curtailed renewable generation, number of generators starts and the system total cost. Results show that, power systems with higher degree of generation flexibility will be able to integrate higher amounts of VRE while minimizing the technical and economic impacts of renewable energies intermittency. Results also show that, diversifying the source of renewable energies applied can result in smoothing out a considerable amount of renewable variability which will also result in positive effects on the technical and economical operation of the power system. Results obtained in this paper can thus provide important insights for the planning process of power systems willing to integrate higher shares of variable renewable energies.

It is important to mention that, although the developed solution method is designed to provide computational speed compared to the other traditional UC solution methods, however, the developed method has the following limitations:

- 1- Generally speaking, the priority list method is based on sorting and committing the generation unit based on their generation cost however, it can't examine all the generator combinations available although it may provide a more feasible solution for the problem. As an example, for a group of four LF generators, the fourth generator can't be activated unless the previous

three generators have been activated first. This behavior represents a tradeoff between providing the speed of computation and the accuracy of the obtained solution and is a common phenomenon in all the priority list-based solution methods.

- 2- The current method considers linear cost functions hence, the generation cost of each generator is assumed to be constant regardless of the output power of the generator (whether operating in full load mode or part loaded mode). Hence, the method still can't capture the cyclic operation of the generation units especially under high penetration of VRE. This drawback can be covered either by using a quadratic programming to represent the quadratic cost functions of the generators or by using a linearized approximation of the generator quadrature cost function.

References

- Adams J.M., O'Malley M., Hanson M., 2010. Flexibility requirements and potential metrics for variable generation: Implications for system planning studies. North American Reliability Council (NERC).
- Bruce A.R.W., Gibbins J., Harrison G.P., 2016. Operational flexibility of future generation portfolios using high spatial- and temporal-resolution wind data. *IEEE Transactions on Sustainable Energy*, Vol. 7, No. 2, April 2016.
- Cochran J., Milligan M., Muller S., Lannoye E. and Holttinean H., 2014. Flexibility in 21st Century Power Systems. National Renewable Energy Laboratory (NREL). 2014.
- Denholm P., Hand M., 2011. Grid flexibility and storage required to achieve very high penetration of variable renewable electricity. *Energy Policy*, Vol. 39, No. 3, pp. 1817-1830.
- Delarue E., D'haeseleer W., 2006. A Mixed Integer Linear Programming Model for Solving the Unit Commitment Problem: Development and Illustration. KU-Leuven Energy Institute, available at: <http://www.mech.kuleuven.be/tme/research>.
- Delarue E., Cattrysse D. and D'haeseleer W., 2012. Enhanced Priority List Unit Commitment Method for Large Scale Systems with Focus on Low Residual Demand. University of Leuven (KU Leuven) Energy Institute.
- Delarue E., Cattrysse D., and D'haeseleer W., 2013. Enhanced priority list unit commitment method for power systems with a high share of renewables. *Electric Power Systems Research*, Vol. 105, pp. 115-123.
- Dieu V.N., Ongsakul W., 2008. Ramp rate constrained unit commitment by improved priority list and augmented Lagrange Hopfield network. *Electric Power Systems Research*, Vol. 78, No. 3, pp. 291-301.
- EniR. O., Akinbami J.K., 2017. Flexibility evaluation of integrating solar power into the Nigerian electricity grid. *IET- Renewable and Power Generation*, Vol. 11, No. 2, pp. 239-247.
- Guan X., Qiaozhu Z. and Papalexopoulos A., 2003. Optimization based methods for unit commitment: Lagrangian relaxation versus general mixed integer programming. IEEE Power & Energy Society General Meeting.
- Grigg C., Wong P., Albrecht P., Allan R., Bhavaraju M. and Billinton R., 1999. The IEEE Reliability Test System-1996: A report prepared by the Reliability Test System Task Force of the Application of Probability Methods Subcommittee. *IEEE Transactions on Power Systems*, Vol. 14, pp. 1010-1020.
- Lannoye E., 2010. Flexibility in power systems. Energy policy Research Group.
- Lannoye E., Flynn D., 2012. Evaluation of Power System Flexibility. *IEEE Transactions on Power Systems*, Vol. 27, No. 2, pp. 922-931.
- Kamh M.Z., Abdelaziz A.Y., Mekhamer S.F. and Badr M.A.L., 2009. Modified augmented hopfield neural network for optimal thermal unit commitment. IEEE Power & Energy Society General Meeting.
- Kumar S.S., Palanisamy V., 2007. A dynamic programming based fast computation hopfield neural network for unit commitment and economic dispatch. *International Journal of Electric Power System Research*, Vol. 77, No. 8, pp. 917-925.
- Lu S., Makarov Y.V., et. al. 2010. Unit commitment considering generation flexibility and environmental constraints. IEEE Power & Energy Society General Meeting.
- Mantawy A.H., 1997. Unit commitment by artificial intelligence techniques – Ph. D Thesis. King Fahd University of Petroleum and Minerals, Dahrhan, Saudi Arabia.
- Miguel C., and Arroyo J.M., 2006. A computationally efficient mixed-integer linear formulation for the thermal unit commitment problem. *IEEE Transactions on power systems* Vol. 21, No. 3, pp. 1371-1378.
- Milligan M., Porter K., DeMeo E., 2009. Wind power myths debunked. *IEEE Power & Energy Magazine*, Vol. 7, No. 6, pp. 89-99.
- Ostrowski J., Anjos M.F., and Vannelli A., 2012. Tight mixed integer linear programming formulations for the unit commitment problem. *IEEE Transactions on Power Systems*, Vol. 27, No. 1, pp. 39-46.
- Padhy N.P., 2004. Unit commitment—A bibliographical survey. *IEEE Transactions on Power Systems*, Vol. 19, No. 2, pp. 1196–1205.
- Price J.E., 2015. Evaluation of stochastic unit commitment for renewable integration in California's energy markets. IEEE Power & Energy Society General Meeting.
- Qiaozhu Z., Guan X., and Cui J., 2002. Unit commitment with identical units successive subproblem solving method based on Lagrangian relaxation. *IEEE Transactions on Power Systems*, Vol. 17, No. 4, pp. 1250-1257.

- Svoboda A.J., Tseng C.L., 1997. Short term resource scheduling with ramp constraints. *IEEE Transactions on Power System*, Vol. 12, No. 1, pp. 77–83.
- Snyder W. L., Powell H. D., Rayburn J., C., 1987. Dynamic programming approach to unit commitment. *IEEE Power Engineering Review*, Vol. PER-7, No. 5, pp. 41-42.
- Senjyu T., Shimabukuro K., Uezato K. and Funabashi T., 2003. A fast technique for unit commitment problem by extended priority list. *IEEE Transactions on Power Systems*, Vol. 18, No. 2, pp. 882–888.
- Troy N., Denny E., O'Malley M., 2010. Base-load cycling on a system with significant wind penetration. *IEEE Transactions on Power Systems*, Vol. 25, No. 2, pp. 1088-1097.
- Victoire T.A.A., Jeyakumar A.E. and Wong Y.W., 2006. A tabu search based hybrid optimization approach for a fuzzy modeled unit commitment problem. *International Journal of Electric Power System Research*, Vol. 76, No. 6-7, pp. 413-425.
- Wang C., Shahidehpour S.M., 1993. Effects of ramp-rate limits on unit commitment and economic dispatch. *IEEE Transactions on Power Systems*, Vol. 8, No. 3.
- Xinda Ke., Ning Lu., Wu Di., Meyer M.K., 2015. A modified priority list-based MILP method for solving large-scale unit commitment problems. IEEE Power & Energy Society General Meeting.
- Zhang L., Capuder T. and Mancarella P., 2016. Unified unit commitment formulation and fast multi-service LP model for flexibility evaluation in sustainable power systems, IEEE Power & Energy Society General Meeting.

Biographical notes

Mohamed M. Abdelzaher received his B.Sc. in electrical engineering from Benha University, Egypt in 2006 and his M.Sc. degree in electrical engineering from Ain Shams University, Egypt, in 2012 and is currently registered as a Ph.D. researcher in electrical engineering in the same university. Since 2007, he has been working for the Egyptian Electricity Holding Company (EEHC) and currently occupies the position as a senior power system planning engineer. Through this position, he has engaged in many studies about the expansion planning of power systems with the different national and international organizations. He is also a member in the Egyptian Sub-Committees of IEC and CIGRE' as well as the WEC Energy Youth Committee.

Hassan Mohamed Mahmoud Moustafa was originally from Cairo, Egypt. He finished his studies in Electrical Engineering B.Sc in 1982 and M. Sc in 1990 at Ain Shams University, Egypt, respectively. After this, he completed his Ph. D in 1996 at El Minia University, Egypt. At present, Dr. Hassan is working as the Managing Director of Information Systems in Egyptian Electricity Company, Ministry of Electricity and Energy, Cairo, Egypt. In line with his professional experiences, Dr. Hassan actively participated in different conferences and working groups to study the development of electrical networks and assessing the benefits of the interconnection between Egypt and on the other countries around the Gulf. Dr. Hassan taught variety of courses for some of the largest and well-known companies around Middle East such as Egypt, Saudi Arabia and UAE focusing on Power System Simulation, Electric Transmission, Load Forecasting, Electromagnetic Transient Programs. He has some publications in national and international journals and conferences. Likewise, he supervises and at the same time became an external examiner of M. Sc and Ph.D Theses.

Almoataz Y. Abdelaziz received the B.Sc. and M.Sc. degrees in electrical engineering from Ain Shams University, Egypt, in 1985 and 1990, respectively, and the Ph.D. degree in electrical engineering according to the channel system between Ain Shams University, Egypt, and Brunel University, U.K., in 1996. He is currently a Professor of electrical power engineering at Ain Shams University. Dr. Abdelaziz is the chair of IEEE Education Society chapter in Egypt, senior editor of Ain Shams Engineering Journal, editor of Electric Power Components & Systems Journal, editorial board member, associate editor and editorial advisory board member of several international journals and conferences. He is also a member in IET and the Egyptian Sub-Committees of IEC and CIGRE'. He has been awarded many prizes for distinct researches and for international publishing from Ain Shams University, Egypt. He has authored or coauthored more than 320 refereed journal and conference papers in his research areas which include the applications of artificial intelligence, evolutionary and heuristic optimization techniques to power system operation, planning, and control.

Said F. Mekhamer was born in Egypt in 1964. He received the B. Sc. and M.Sc. degrees in electrical engineering from Ain Shams University, Cairo, Egypt, and the Ph.D. degree in electrical engineering from Ain Shams University with joint supervision from Dalhousie University, Halifax, NS, Canada, in 2002. He is currently an Associate Professor in the Department of Electric Power and Machines, Ain Shams University. His research interests include power system analysis, power system protection, and applications of AI in power systems.

Mohamed A. L. Badr was born in Cairo, Egypt in 1944. He received the B. Eng. Degree (Honors) and M. Sc. in electrical engineering from Ain Shams University in Cairo, Egypt in 1965 and 1969, respectively. He received Ph. D degree from the Polytechnic Institute of Leningrad in the former Soviet Union in 1974. Currently he is emeritus professor of electrical power and machines in Ain Shams University. Dr. Badr had been Professor of Electrical Machines in Ain Shams University since 1984. He had been the chairman of the Dept. of Electrical Power and Machines for 6 years. He headed the Electrical Engineering Dept. at the University of Qatar at Doha for five years. Dr. Badr is a senior member IEEE since 1990. Dr. Badr has supervised a large number of Ph. D. and M. Sc. research work in electrical machines and power systems, the areas in which he is interested. He is the author and co-author of many published refereed papers.

Received August 2017

Accepted March 2018

Final acceptance in revised form March 2018