

DETERMINATION OF BROMOXYNIL AND IOXYNIL IN THE PRESENCE OF CARBAMATES BY SUPPORTED LIQUID MEMBRANE-LIQUID CHROMATOGRAPHY IN RIVER WATERS

Titus Motswadi Maswabi¹ and Mathew M. Nindi*

Department of Chemistry, University of Botswana, Private Bag UB 00704, Gaborone, Botswana
¹Now @ Botswana Bureau of Standards, Private Bag BO 48, Gaborone, Botswana

(Received August 4, 2002; revised April 17, 2003)

ABSTRACT. Sample pre-treatment and enrichment using the supported liquid membrane (SLM) technique for the determination of phenolic nitrile herbicides in presence of carbamates in river water samples was investigated. The uncharged herbicide molecules from the flowing aqueous solution diffuse through an immobilized water-immiscible organic solvent, supported by a porous polytetrafluoroethylene (PTFE) membrane, and trapped in a stagnant acidic acceptor phase in an ionic form. Using n-undecane as a membrane solvent, the SLM extraction methodology was successfully used for the enrichment and separation of phenolic nitrile herbicides in environmental waters with extraction efficiencies of 60% or better. A RDS (%) of 2.1 and 1.8 was obtained for the extraction of ioxynil and bromoxynil from river water, respectively.

KEY WORDS: Bromoxynil, Ioxynil, Phenolic nitrile herbicides, Carbamates, Supported liquid membrane, Sample pre-treatment, Sample enrichment

INTRODUCTION

Pesticides residues and their degradation products, produced by a combination of hydrolytic, photochemical and microbial processes, are found in various complex matrices at very low concentration levels. The nature of the sample necessitates the use of pre-concentration and/or cleanup prior to the separation and analysis techniques. The detection level of these residues, especially in environmental waters, seems to depend more on the isolation and enrichment procedure chosen rather than on the method used for final determination. Sample pretreatment and enrichment is therefore, a prerequisite for most environmental trace samples. Most often, liquid-liquid and liquid solid extractions are used for aqueous samples. Solid phase extraction (SPE), a technique well known for its large enrichment capacity, has been used for preconcentration and/or cleanup of pesticides in aqueous samples. However, limitations of SPE have been identified such as: i) overloading of the stationary phase, ii) breakthrough, iii) contamination, and iv) competitive adsorption. Liquid-liquid extraction (LLE) is still commonly used for sample preparation method for the determination of some pesticides in aqueous samples. Similarly, limitations of the LLE are quite large and included: i) long extraction time, ii) labour intensive, iii) emulsion formation, iv) use of large organic solvents, v) evaporation of large volumes of solvents and vi) difficult to automate. The use of semi-permeable membrane, such as supported liquid membrane (SLM) extraction has gained popularity since its introduction by Audunsson [1]. The theory and the principle of the extraction process in an SLM unit, is well documented by Jönsson and Mathiasson [2, 3]. The analyte usually diffuse across the membrane due to the difference in water/organic liquid partition coefficient of the analyte in the ionic and non-ionic forms. To enhance such differences, the pH of analyte in the donor is adjusted such that at least 99% of the analyte is non ionic, similarly the pH of the acceptor phase is adjusted to promote ionization of the extracted analyte. Parameters that promote maximum extraction of the analyte are of major interest in most application. In addition to pH dependence

*Corresponding author. Fax: 267-585 097. E-mail: Nindimm@mopipi.ub.bw

of the extraction efficiency it has been reported that the extraction efficiency of analytes is also temperature dependent [4]. Various applications of the SLM extraction have been demonstrated in large variety of compounds and metals in different matrices that included amines in urine, herbicides in water [5], triazine herbicides in water [6], nitrophenols, metals in urine, etc. [7]. The supported liquid membrane extraction method provides, in addition to high enrichment factors, also a high degree of cleanup.

Bromoxynil and ioxynil were introduced in the 1960s [8] primarily for control of a narrow range of broad-leaved weeds in cereals, sugar cane, onions and grasses. Their practical importance was due to the fact that, while most grasses tolerate them, they attack the seedlings of several troublesome broad-leaved weeds that were not readily controlled by phenoxyalkanoic acid herbicides. Ioxynil is the preferred herbicides for weed control in newly sown lawns and it is also used for weed control in onions and leeks. Both bromoxynil and ioxynil are often used in spring cereals to control weeds resistant to 2-methyl-4-chlorophenoxyacetic acid (MCPA) and 2,4-dichlorophenoxyacetic acid (2,4-D). The carbamates are usually used as insecticides and are the last group of pesticides to be introduced into the market despite the fact that their insecticidally active structures were discovered over fifty years ago [9]. The most popular member of the carbamates group is carbaryl. It is noted for its low mammalian toxicity, environmental degradation and broad spectrum of insect toxicity. Carbamates tend to degrade into their metabolites soon after application. The metabolites are known to be active and sometimes even more active than the parent group. When monitoring pesticides residue that include carbamates it is worth taking their metabolites into account.

In this paper, SLM extraction is used as a sample preparation of phenolic nitrile herbicides; ioxynil and bromoxynil in the presence of carbamates: aldicarb, baygon, oxamyl and propham. The results of sample preparation of the phenolic nitrile herbicides in the presence of carbamates by supported liquid membrane (SLM) are presented.

EXPERIMENTAL

Chemicals and reagents

The phenolic nitrile herbicides used were ioxynil (99%), bromoxynil (99.7%), and carbamates: aldicarb (99%), baygon (99%) oxamyl (98.0%) and propham (99.5%) were purchased from Chem Service (West Chester, USA). The chemical structures, names and pK_a values of the phenolic nitrile herbicides and carbamates are included in Table 1.

The liquid membrane consisted of a combination of two organic solvents, di-hexyl ether (99%) from Aldrich (Steinheim, Germany), n-undecane (99%) from Sigma (St Louis, USA). Sulphuric acid (99%), sodium hydroxide pellets (98%), and ethanol (99%) were from Saarchem (Krugersdorp, South Africa). Sodium dihydrogen orthophosphate dihydrate ($Na_2PO_4 \cdot 2H_2O$) (98%) and disodium hydrogen phosphate ($Na_2HPO_4 \cdot 12H_2O$) (99.5%) were both from NT Laboratory (Johannesburg, South Africa). The disodium hydrogen phosphate and sodium dihydrogen orthophosphate dihydrate were used as buffers (with a volume ratio of 45.75 mL of 0.2 M Na_2HPO_4 : 4.25 mL 0.2 M NaH_2PO_4) diluted to 100 mL to give a pH of about 7.8.

HPLC grade acetonitrile and methanol (BDH, Poole, England) were used for all chromatographic separations. Water was purified with Elgastat UHQPS machine, (High Wycombe, Bucks, England).

Table 1. The pesticides used in this study and their respective pK_a values.

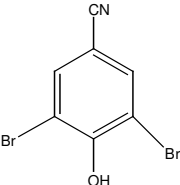
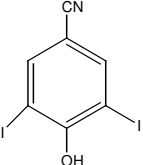
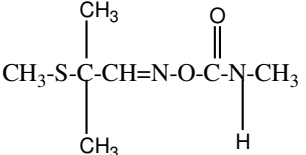
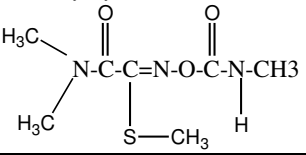
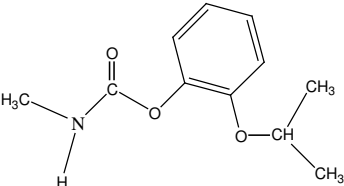
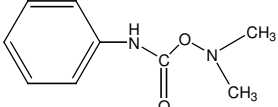
Ref. #	Systematic name	Common names	CAS number	pK _a *
1	3,5-Dibromo-4-hydroxybenzonitrile 	Bromoxynil	1689-84-5	4.06
2	3,5-Diiodo-4-hydroxybenzonitrile 	Ioxynil	1689-83-4	3.96
3*	2-Methy-2-methylthio-propioaldehyde O-methylcarbamoyl oxime 	Aldicarb	116-06-3	13.8 ± 0.5, -1.1 ± 0.7
4*	Methyl-N',N'-dimethyl-N-methyl- carbamoyoxy-1-thiooxamidate 	Oxamyl	23135-22-0	12.4 ± 0.5, -1.5 ± 0.7
5*	2-Isopropoxy-phenyl N-methyl carbamates 	Baygon	114-26-1	11.9 ± 0.5, -1.6 ± 0.7
6*	Isopropyl-N-phenyl carbamates 	Propham	122-42-1	11.2 ± 0.5, -1.6 ± 0.5

*pK_a values for compounds 3-6 were calculated from a computer program, (ACD/log P DB) version 3.0, Advances Chemical Development Inc., Toronto, Canada.

Stock solutions and working standards preparations

Master standard solutions of each herbicides and carbamates were dissolved in minimal methanol and made up the concentrations of 4 mg/mL in water. An aqueous solution of herbicides mixture (ioxynil and bromoxynil) was prepared by spiking water at pH 3.01 (the pH adjusted with 0.20 M sulphuric acid) with master standard solutions of each herbicide. A series of standard solutions for calibration in the range 0.1–2.0 mg/L were prepared by dilution of the master standard with HPLC mobile phase. These were prepared daily and were kept in the refrigerator at 4 °C. The master standard solutions were kept in the freezer at –18 °C and were stable for several months at this temperature.

A series of calibration standards in the range of 5–30 mg/L were obtained by diluting the master standard solutions with HPLC mobile phases (30% acetonitrile : 70% water with 1% acetic acid). The standards were kept at 4 °C and were prepared weekly. Environmental water samples were collected from Tlhwane and Metsimaswaane rivers. The two rivers enter Gaborone Dam from the south and are 4 km apart, both originating from South Africa.

Preparation of environmental samples prior to analysis

The two environmental water samples from Tlhwane and Metsimaswaane rivers were filtered with Whatman filter paper # 1 (Maidstone, UK) to remove particulate matter and then stored at 4 °C temperature. After filtration the pH of the water was adjusted to the required pH with 0.2 M sulphuric acid. For supported liquid membrane pre-treatment, the water was directly used without further filtration. The water sample processed by solid phase extraction was further filtered by 0.45 µm filter to remove microparticles that could clog the cartridges. Similarly the pH of water sample was also adjusted with glacial acetic acid to the required pH. Spiking of the water was performed after microfiltration.

Equipment

Liquid chromatograph

Phenolic nitrile herbicides and carbamates mixture were separated on a LC with UV detection. The HPLC system consisted of Waters LC M-45 solvent delivery system, with Lambda-Max Model 481 detector and Model 680 controller (Waters Associates, Milford, Massachusetts) and a Perkin Elmer Integral 4000 (Beaconsfield, Buckinghamshire, UK). The separation was performed on a Hewlett Packard C₁₈ Hypersil ODS, 5 µm x 2.1 mm x 200 mm column (Milford, Massachusetts, USA).

Supported liquid membrane

The SLM extraction device (fabricated at Department of Analytical Chemistry, Lund University, Lund, Sweden) consisted of two circular PVDF (poly (vinylidene difluoride) blocks (diameter 120 mm, thickness 15 mm) with the grooves like an Archimedes spiral, depth 0.25 mm, width 1.5 mm and length 250 cm giving a total volume of about 0.95 mL (Figure 1). Both sides of the holder were backed with aluminum blocks of 6 mm thickness, in which threads for the clamping screws were machined, to make the assembly stable. In addition, the donor channel of the PTEE (polytetrafluoroethylene) block was equipped with an O-ring, outside the grooves for sealing the flow system. Figure 2 shows the setup of SLM extraction units used in this experiment.

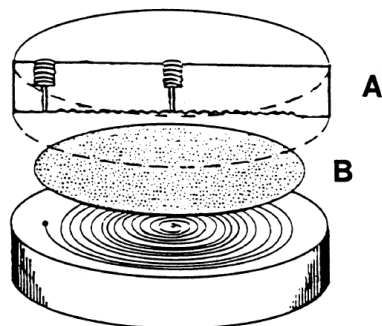

Figure 1. The membrane separator. A: aluminum back up, B: PTFE block with grooves like Archimedes's spiral, and C: impregnated liquid membrane.

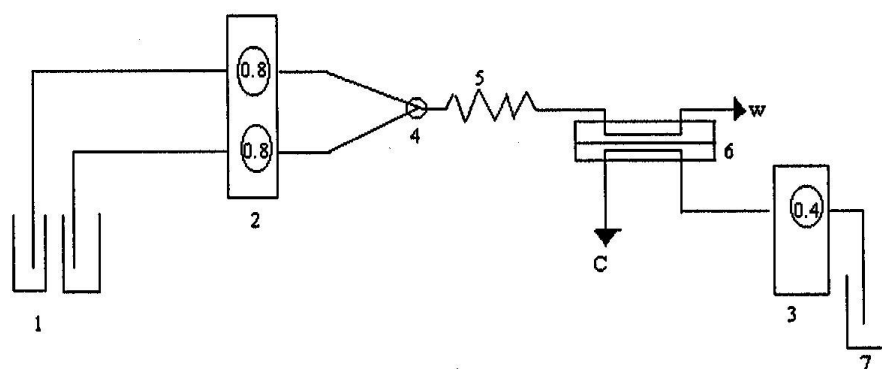

Figure 2. Set-up of the flow system for the supported liquid membrane. 1 = sample solution and donor buffer reservoirs, 2 and 3 = peristaltic pumps for the donor and acceptor phases, respectively, 4 = PTFE tee connection, 5 = mixing coil, 6 = membrane extraction unit, 7 = acceptor solution reservoirs, w = waste and c = extract collection point.

The liquid membrane support was a Millipore FG (Millipore, Bedford, MA, USA) with an average pore size of 0.2 μm , a total thickness of 175 μm of which about 115 μm is polyethylene backing, and a porosity of 70%. The liquid membrane was prepared by immersing the membrane support in the organic solvent to be immobilized (50% n-undecane in di-n-hexylether) for a period of 30 min. The soaked membrane was placed between the two PTFE blocks, with the rough side of the membrane facing the donor side and the whole construction was clamped together tightly and evenly with six screws. Thus, the two channels of SLM extraction unit, the donor (feed) and the acceptor (receiving) compartments are separated with the supported liquid membrane. After installation of the impregnated membrane in the separator, both channels were flushed with UHP water to remove excess of the organic solvent from the surface of the membrane.

Two peristaltic pumps, Gilson Minipuls 3, (Villiers-Le-Bel, France) were used to control the flow rates of the donor and acceptor phases independently. The tubes used for pumping

solutions were acid-resistant "acid-Flexible" (Elkay Products, Shrewsbury, MA, USA) with internal diameters of 1.2 mm for the donor and 0.60 mm for the acceptor. The various parts of the flow system were connected with 0.5 mm internal diameter PTFE tubing and Altex screws fittings. The sample and buffer in the donor stream were emerged in a PTFE tee connection and then mixed in a coil (1.0 m x 0.5 mm i.d. coiled PTFE tubing) before entering the donor channel of the membrane device.

Supported liquid membrane enrichment and separation procedures

The aqueous samples of pesticides mixture and the buffer solution (made of sulphuric acid adjusted to about pH 3.0 with saturated solution of sodium hydroxide) were pumped with a peristaltic pump and delivered to the extraction system with a total donor flow rate of 0.8 mL/min (sample to buffer volume ratio of 2:1) for 45 min. The donor channel was then by flushed with the donor buffer solution for 5 min, while the acceptor phase was maintained stagnant at buffer pH 7.8 (made of disodium hydrogen phosphate and sodium dihydrogen orthophosphate dihydrate). The system was left to stand for 10 min to allow diffusion of the analytes from the membrane to the acceptor phase. After 10 min, the stagnant acceptor solution containing the enriched pesticides was quantitatively transferred into a 2 mL volumetric flask containing 0.5 mL of 1 M sulphuric acid until the volume has come to the 2 mL mark of the volumetric flask. The acceptor channel was then flushed through with the acceptor solution before the next extraction for 5 min. A 20 μ L aliquot of the enriched sample was introduced into the HPLC system. For the reversed phase chromatographic separation of the mixture phenolic nitrile herbicides pre-concentrated from SLM extraction, a mobile phase consisting of 52% methanol and 48% water with 1 % acetic acid was utilized. All mobile phases were degassed for 30 min by either ultra-sonication or purging with argon gas. All analyses were carried out isocratically at a mobile phase flow rate of 0.3 mL/min and monitored at 254 nm. Five point calibration graphs for the phenolic nitrile herbicides and carbamates were prepared by injection of standards of concentration range 0.1–10 mg/L. No SLM extraction was involved in the construction of calibration curve. The standards at this concentration range were prepared weekly. Each of the five points was based on triplicate injections and measurements of peak heights. All the graphs were linear with correlation coefficients of 0.995 or better with insignificant intercepts at the 95% confidence level.

RESULTS AND DISCUSSION

In the enrichment process with the supported liquid membrane the pesticides being extracted were largely uncharged when entering the donor channel into the membrane separator. The pesticides then diffused through the hydrophobic liquid membrane to the acceptor channel, which contained a buffer at pH 7.8. The acceptor phase was kept stagnant during the whole extraction period and when these pesticides reached the acceptor they were ionized and hence were unable to diffuse back to the donor channel, thus enriched. Smaller interfering molecules are presumably not extracted into the membrane but instead pass through the donor channel to waste. Neutral molecules distribute themselves between the two phases and thus enrichment for them is unlikely to occur.

For the efficient enrichment to be achieved, the conditions governing the transfer of analytes from the donor to the acceptor across the membrane and the entrapment of the analytes in the acceptor side must be optimized. The following conditions must be fulfilled for enrichment:

- (i) The analytes in the sample solution must form uncharged species before or in connection with the diffusive transport across the membrane.
- (ii) The partition coefficient (K_p) of the analyte molecules between the organic solvent and the aqueous donor phase, should be as large as possible for the target molecules, while for the interfering compounds, it should be low.
- (iii) An efficient trapping (conversion of analytes into the inactive form that prevents back-diffusion into the donor channel) must take place on the acceptor side.

Hence, the following variables were optimized: membrane solvent, acceptor pH, donor stream pH, extraction time, flow-rate, linearity and carry over effect. Optimum parameters obtained for the SLM extraction of phenolic nitrile herbicides and carbamates pesticides are shown in Table 2.

Table 2. Optimum parameters of SLM extraction of phenolic nitrile herbicides, bromoxynil and ioxynil.

Parameter	Optimum value
Membrane solvent	50% undecane : 50% dihexyl ether
Donor pH	pH 3.0
Acceptor pH	pH 7.8
Extraction time	45 min
Flow-rate	0.8 mL/min
Linearity	0.01–100 ppb
Carry over effect	< 1%

SLM extraction of spiked environmental water samples

Spiked water samples from Metsimaswaane and Tlhwane rivers were treated with supported liquid membrane. The results obtained from the spiked waters from these rivers were compared to those of water (control sample, *i.e.* spiked UHP water) at various concentrations of the analytes (Table 3). The concentration of the analyte used to spike the river waters and control sample (UHP water) ranged from 10 to 1000 ppb. The data obtained indicated that there was no significant difference in extraction efficiencies of analyte at concentrations between 10 and 100 ppb for bromoxynil and ioxynil herbicides. However, the extraction efficiencies dropped from extraction averages of 64 to 40% for analytes of concentration above 100 ppb. The decrease of extraction efficiencies at concentrations above 100 ppb is probably due to the back diffusion occurring at these concentrations. Using similar dimensions and configuration SLM extraction units other workers have reported similar results [10, 11]. In such situations reduction of extraction time has been proposed as a solution to minimizing back diffusion at high concentrations. The recovery of carbamates with SLM extraction was unsuccessful. There are number of possible reasons that could be responsible for the failure of recovery of carbamates by SLM extraction;

- i) Carbamates are always neutral and therefore do not form charged species in the acceptor solution or membrane
- ii) The carbamates are very polar, *i.e.* much more polar than bromoxynil and ioxynil, therefore will have very low partition coefficients.

This would explain why the carbamates were not extractable. However, the SLM extractions of herbicides and carbamates mixture were carried out at variable donor phase pH (2–13). The carbamates failed to extract across the pH range probably due reasons stated above.

Table 3. SLM extraction of phenolic nitrile herbicides spiked environmental water samples at different analyte concentrations.

Concen. (ppb)	Efficiency (%) and (RSD %)					
	Reagent water		Tlhwane water		Metsimaswaane water	
	Br	Io	Br	Io	Br	Io
1000	35.00 (7.1)	44.45 (4.7)	39.80 (1.4)	50.40 (1.1)	34.00 (1.3)	27.00 (8.8)
500	34.49 (3.8)	29.59 (5.6)	46.80 (2.5)	39.80 (3.4)	65.10 (2.5)	57.90 (1.4)
100	66.35 (0.5)	63.32 (3.6)	70.30 (2.8)	56.90 (3.8)	68.04 (3.0)	68.69 (2.2)
50	66.01 (0.5)	69.59 (1.1)	66.70 (1.3)	67.10 (1.0)	59.70 (3.2)	67.30 (2.3)
10	67.00 (5.0)	72.70 (5.1)	65.02 (2.2)	64.00 (6.9)	66.00 (7.4)	70.00 (8.2)

RSD (%) is the percentage relative standard deviation, n = 4, Br = Bromoxynil and Io = Ioxynil.

The repeatability of extractions for ioxynil and bromoxynil were tested at herbicides concentrations of 100 ppb and data obtained are shown in Table 4. A 1.0 litre of Metsimaswaane river water was divided into 5 equal portions of 200 mL [12]. These portions were then pre-concentrated at optimum conditions for the method. Both bromoxynil and ioxynil herbicides had extraction efficiency averages of above 68% and with RSD of 1.8% and 2.1%, respectively. The low within run RSD (%) and low precision of below 10% was an indication that the extractions of the two herbicides were repeatable, in addition this value falls within acceptable limits [13]. Figure 3 shows a typical chromatogram of a separation of 0.10 ppm of phenolic nitrile herbicides spiked in UHP water, and pre-concentrated by SLM extraction unit at optimum conditions. Figure 4 shows typical chromatogram of phenolic nitrile herbicides and carbamates mixture spiked in UHP water.

Table 4. Repeatability of SLM extraction results of 0.01 ppm ioxynil and bromoxynil.

Aliquot	Efficiency (%)	
	Ioxynil	Bromoxynil
1	69.35 (2.4)	67.45 (0.5)
2	69.68 (1.2)	69.36 (2.6)
3	68.33 (2.4)	68.41 (0.6)
4	66.31 (3.8)	66.23 (1.2)
5	69.77 (2.7)	68.76 (1.4)
\bar{x}_w	2.1	1.8

\bar{x}_w = within run precision. The value in brackets is the % relative standard deviation, n = 4.

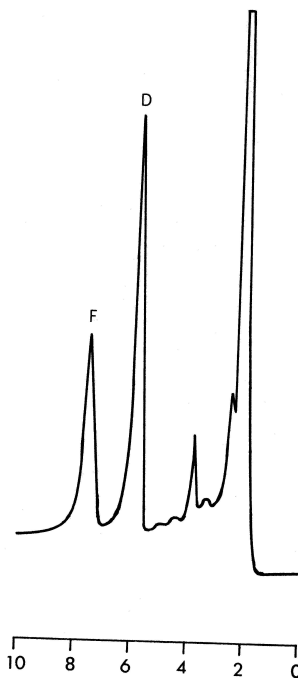

Figure 3. Typical LC-UV chromatogram of 0.10 ppm of phenolic nitrile herbicides spiked in UHP water preconcentrated by SLM unit at optimum conditions. D = bromoxynil and F = ioxynil.

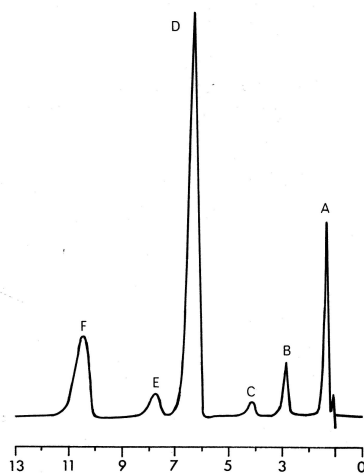

Figure 4. Typical chromatogram (LC-UV) of 0.10 ppm of phenolic nitrile herbicides and carbamates mixture spiked in UHP water: A = oxamyl, B = aldicarb, C = baygon, D = bromoxynil, E = propham and F = ioxynil.

CONCLUSIONS

It has been demonstrated that SLM extraction can be used to preconcentrate trace amounts of pesticides in environmental water samples with extraction efficiencies of about 68% for both ioxynil and bromoxynil. The method was validated against solid phase extraction (data not presented here) and the standard deviation of the methods revealed SLM extraction method to be precise, 1.8 and 2.1 RSD (%) for bromoxynil and ioxynil, respectively. A comparative study also showed that SLM extraction is more suitable for environmental samples than SPE because of the many advantages it proved to have in the extraction process.

ACKNOWLEDGEMENTS

This work was made possible by financial supported from the Swedish Agency for Research in Developing Countries (SAREC) for TMM and the University of Botswana. The authors would like to thank Professor Jan Åke Jönsson for his constructive discussion on this work. We would also like to thank Mr. G. Koorutwe for assisting with cartographic work.

REFERENCES

1. Audunsson, G. *Anal. Chem.* **1986**, 58, 2714.
2. Jönsson, J.Å.; Mathiasson, L. *Trends Anal. Chem.* **1992**, 11, 106.
3. Jönsson, J.Å.; Mathiasson, L. *Trends Anal. Chem.* **1999**, 18, 318.
4. Chimuka, L.; Nindi, M.M.; ElNour, M.E.M.; Frank, H.; Velasco, C. *J. High Resol. Chromatogr.* **1999**, 22, 417.
5. Audunsson, G. *Anal. Chem.* **1988**, 60, 1340.
6. Chimuka, L.; Nindi, M.M.; Jonsson, J.A. *Intern. J. Environ. Anal. Chem.* **1997**, 69, 429.
7. Jönsson, J.Å.; Mathiasson, L. *J. Chromatogr. A* **2000**, 902, 205.
8. Hassall, A.K. *The Biochemistry and uses of Pesticides*, 2nd ed., MacMillian Press Ltd: London; **1990**, pp 410-415.
9. Kuhr, R.J.; Dorough, H.W. *Carbamates Insecticides Chemistry, Biochemistry and Toxicology*, 3rd ed., CRC Press: Florida; **1979**.
10. Jönsson, J.Å.; Lövkvist, P.; Auddunsson, G.; Nilve, G. *Anal. Chim. Acta* **1993**, 277, 9.
11. Chimuka, L. *M.Sc. Dissertation*, University of Botswana, Gaborone, Botswana, **1996**.
12. DiCorcia, A.; Marchetti, M.; Samperi, R. *Anal. Chem.* **1989**, 61, 1363.
13. Linder, W.; Wainer, I.W. *Analytical Separation News* **1988**, No. 1, 1-8.